

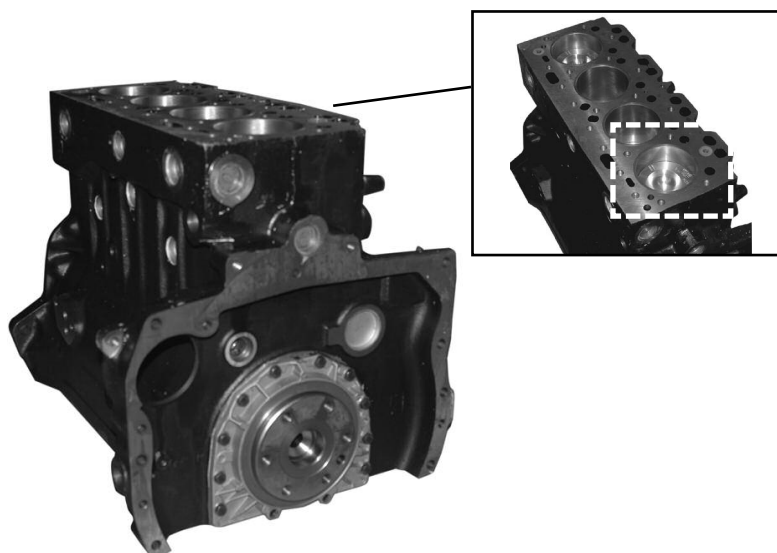

## PERKINS PARTS

**Nouvelle disponibilité en short bloc (complet)**  
**News availabilities of short bloc (complete)**  
**Neue verfügbare Motorblock (Komplett)**  
**Nieuwe beschikbare motorblok (kompleet)**  
**Nuevas disponibilidades en motor bloqueo (completo)**



Short block Motorblock Motorblok Motor bloqueo	Piston Kolben Zuiger Pistón	Model	Cylinders	Nominal HP
30/6001-5	-	A4.248	4	80
30/6001-6	-	A4.236		70

**Consultez nous pour tous renseignements complémentaires sur cette nouvelle gamme**  
**Consult us for further information about this new range**  
**Fragen Sie uns für nähere Angaben zu diesem Programm**  
**Raadpleeg ons voor nadere inlichtingen omtrent dit gamma**  
**Consultar nosotros para todas información complementarias con esta nueva gama**







## PERKINS PARTS

### Injection - Injection - Einspritzung - Injctie - Inyección

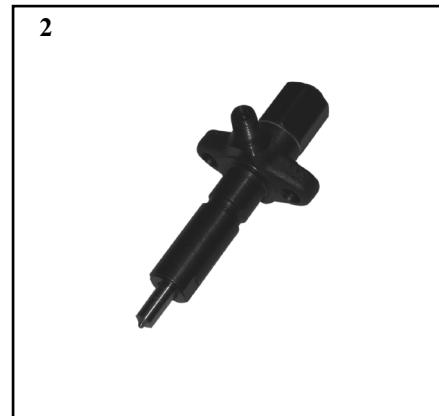
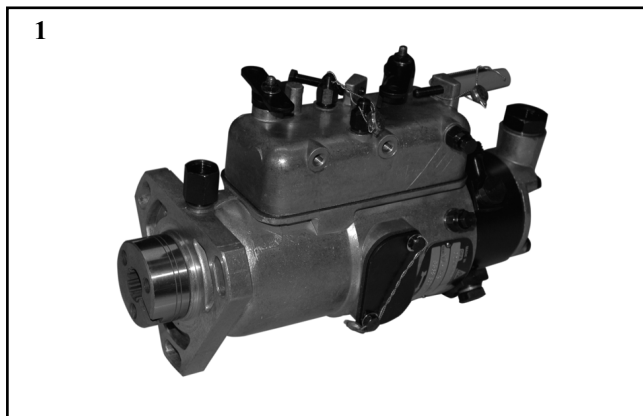

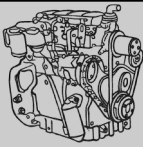
	Fig. Abb. Afb. Fig.	Parts N°	Description Beschreibung Omschrijving Descripción	Rotation Drehrichtung Draairichting Rotación
D3.152	1	30/7100-1854	Pompe injection	↻
4.236 4.248		30/7100-1855	Injection pump	↻
6.354.4		30/7100-1856	Einspritzpumpe Brandstofpomp Bomba inyección	↻
3, 4 & 6 Cyl. Perkins	2	30/117-238	Injecteur complet Complete injector Komplette duse Komplete verstuiver Tobera completo	-









## PERKINS PARTS

### REFROIDISSEUR D'HUILE - OIL COOLER - ÖLKÜLHER - OLIE KOELER - REFRIGERADOR ACEITE

	N° de construction <i>Build number</i>	Ref.	
A4.236	LD, LJ, LH	30/6097-3 (P2486A219)	
1004.4	AA, AB, AE, AJ, AK, AQ, AR, AS		





## PERKINS PARTS

**Nouvelle disponibilité en moteurs perkins complets, sans compresseur, démarreur, alternateur et volant moteur**  
**News availabilities of perkins complete engine without compresor, starter, alternator and fly wheel**  
**Neue verfügbare Motor perkins komplette ohne Kompressor, Anlasser, Drehstromlichtmaschine, Schwungrad**  
**Nieuwe beschikbare motor perkins komplet, compressor, startmotor, Wisselstroomdynamo, vliegwiel**  
**Nuevas disponibilidades en motor perkins sin compresor, motor de arranque, alternador y volante de motor**



	30/6000-1	30/6000-2	30/6000-3
Model	AD3.152	A4.236	A4.248
Cylinders	3	4	4
Nominal HP	47	70	80

**Consultez nous pour tous renseignements complémentaires sur cette nouvelle gamme**  
**Consult us for further information about this new range**  
**Fragen Sie uns für nähere Angaben zu diesem Programm**  
**Raadpleeg ons voor nadere inlichtingen omtrent dit gamma**  
**Consultar nosotros para todas información complementarias con esta nueva gama**

Les références des pièces sont indicatives.  
Nos pièces ne sont pas d'origine.

*Part numbers are quoted for reference purposes only.  
Our parts and accessories are not original.*







# TRACPIECES

## bepco tractor parts

### PRODUCT NEWS-SHEET

PAGE : N° 7045

DATE : 12/99

# PERKINS "1000"

Tableau d'identification des tracteurs et des moteurs



Tractors and engines application chart

Vergleichsliste Traktor- und Motortypen

Vergelijingslijst trekkermodellen-motortypen

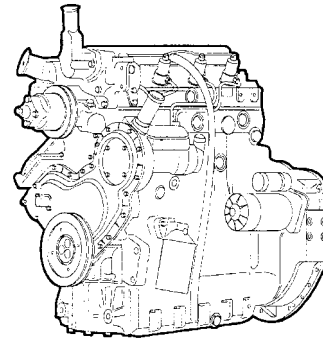
Tractores y motores, tabla de aplicaciones



	Modèle Model Modelle Model Modelo	Application Application Anwendung Toepassing Aplicación	Moteur Engine Motor Motor Motor		Modèle Model Modelle Model Modelo	Application Application Anwendung Toepassing Aplicación	Moteur Engine Motor Motor Motor
CATERPILLAR	4161/4281	Backhoe Loader	4.40	CLAAS	D098SL	Combine	T6.60
	4261		T4.40		Dominator 88		
	4361/4381				Dominator 98		
HYSTER	S80-5155XL	Fork Lift Truck	4.40	KOMATSU	PC210	Hydraulic Excavator	T6.60
	H165-280		6.60		PC240		
JCB	712	Dumper	6.60	MASSEY FERGUSON	MF3075, 8937	Agricultural Tractor	1004.4
	809/360 Degree	Excavator	4.40		MF4225, 4235, 4240		4.41 Blue
	820		T6.60		MF4225, 6110, 6120		4.41 Green
	415		T4.40		MF4235, 6130, 6140, 6150		
	410	Loader	4.40		MF4245, 4255, 4265		4.41
	435		T6.60		MF396, 399, 3085, 3095, 3115, 3120		1006.6
	408		Shovel Loader		4.40		MF3125, 3635, 3645, 3655
	412/416				MF4260, 4270		1000-6 Blue
	530/540	Telescopic Handler	T4.40		MF4260, 4270, 8110, 8120		1006-6 Green
	530/540				MF6160, 6170, 6180, 6190		6.60
	716	Truck-Dumper	T6.60		MF8110, 8120, 8130		T6.60
	MANITOU		Telescopic Handler		4.40		

Les références des pièces sont indicatives.  
Nos pièces ne sont pas d'origine.



**"THE RELIABLE SERVICE"**



Part numbers are quoted for reference purposes only.  
Our parts and accessories are not original.

# PERKINS "1000"

Vilebrequin et pièces connexes

Crankshaft and related parts

Kurbelwelle & Einzelteile

Krukas en bijhorende delen

Cigüeñales y piezas relacionadas

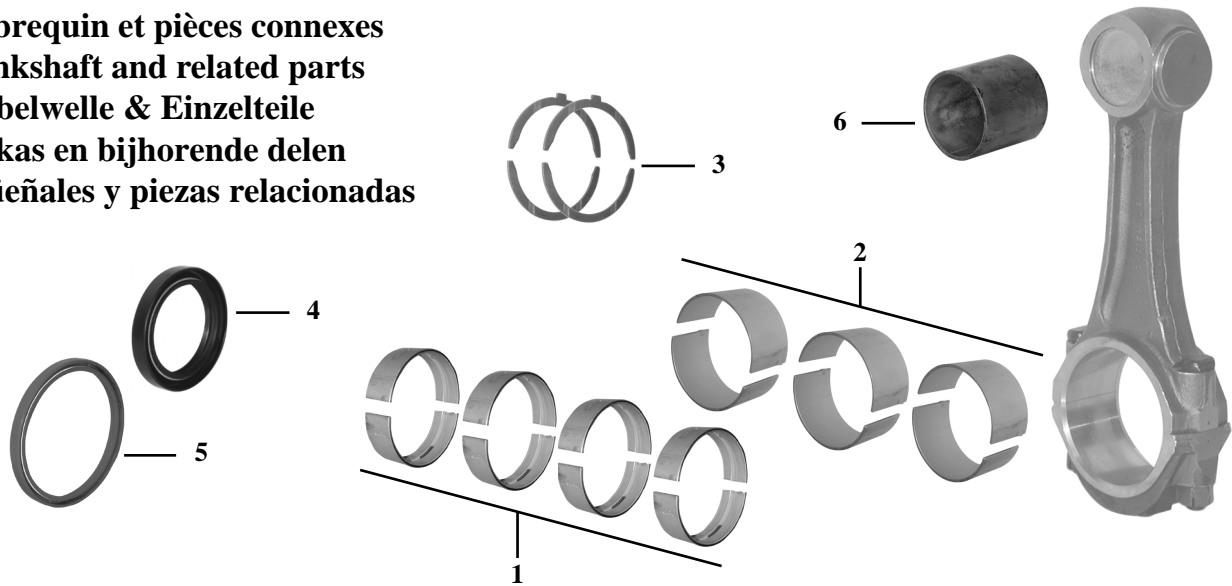

	1	2	3	4	5	6
	Coussinets de palier Main bearing set Hauptlagersatz Hoofdlagerset Cojinete de bancada	Coussinets de bielle Conrod bearing set Pleuellagersatz Drijfstanglagerset Cojinete de biela	Epaisseur latérale Trust washer Anlaufscheiben Axiaallager Arandela	Bague avant Front oil seal Dichtring (Vorn) Keerring voor Retén delantero	Bague arrière Rear oil seal Dichtring (Hinten) Keerring achter Retén trasero	Bague de bielle Small end bush Pleuelbuchsen Pistonpenbus Cojinete pie de biela
MF3075, 8937	30/2-3 (735168M91, 81558)	30/3-28 (3637791M91, U5ME0002)	30/6-3 (2 x 747128M1, + 2 x 747129M1)	30/11-11 (1447690M1, 2418F436)	30/13-4 (1447691M1, 2418F475)	30/28-16 (744971M1, 31134131)
MF4245, 4255, 4265		30/3-3 (736950M91, 85042)				30/28-2 (733767M1, 31134123)
MF4225, 4235, 4240		30/3-28 (3637791M91, U5ME0002)				30/28-16 (744971M1, 31134131)
MF4225, 6110, 6120						
MF4235, 6130, 6140, 6150						
MF396, 399, 3085, 3095, 3115, 3120	30/2-52 (3637020M91, U5MB0007)	30/3-4 (736934M91, 85043)				30/28-2 (733767M1, 31134123)
MF3125, 3635, 3645, 3655		30/3-29 (3637024M91, U5ME0003)				30/28-16 (744971M1, 31134131)
MF4260, 4270, 6160, 6170 (⇔ F014037)		30/3-4 (736934M91, 85043)				30/28-2 (733767M1, 31134123)
MF4260, 4270, 6170 (F014038⇔), 6180, 6190, 8110, 8120		30/3-29 (3637024M91, U5ME0003)				30/28-16 (744971M1, 31134131)

✚ Les coussinets de palier et de bielle sont disponibles en côte réparation 0,25mm (0.010"), 0,51mm (0.020"), 0,76mm (0.030") et 1,02mm (0.040").  
Ajouter respectivement les suffixes A, B, C ou D.

✚ Main bearing sets and conrod bearing sets are available in 0,25mm (0.010"), 0,51mm (0.020"), 0,76mm (0.030") and 1,02mm (0.040") undersize.  
When ordering state standard part number with suffix A, B, C or D respectively.

✚ Alle Haupt- und Pleuellager sind auch in den Übermassen 0,25mm (0.010"), 0,51mm (0.020"), 0,76mm (0.030") und 1,02mm (0.040") lieferbar.  
Bitte ergänzen Sie die Bestell-Nr. mit A, B, C oder D.

✚ De hoofd en drijfstanglagersets zijn beschikbaar in overmaat 0,25mm (0,010"), 0,51mm (0,020"), 0,76mm (0,030") en 1,02mm (0,040").  
Voeg dan bij aan het bestelnr.: "A", "B", "C" of "D".

✚ Los casquillos de bancada y biela están disponibles a 0,25mm (0.010"), 0,51mm (0.020"), 0,76mm (0.030") y 1,02mm (0.040").  
Añadir en el pedido el sufijo A, B, C o D respectivamente.

Les références des pièces sont indicatives.  
Nos pièces ne sont pas d'origine.

Part numbers are quoted for reference purposes only.  
Our parts and accessories are not original.



# TRACPIECES

## bepco tractor parts

### PRODUCT NEWS-SHEET

PAGE : N° 7047

DATE : 12/99

# PERKINS "1000"

**Joints de moteur**  
**Engine gasket sets**  
**Dichtsätze für Motor**  
**Motordichtungen**  
**Juntas de motor**

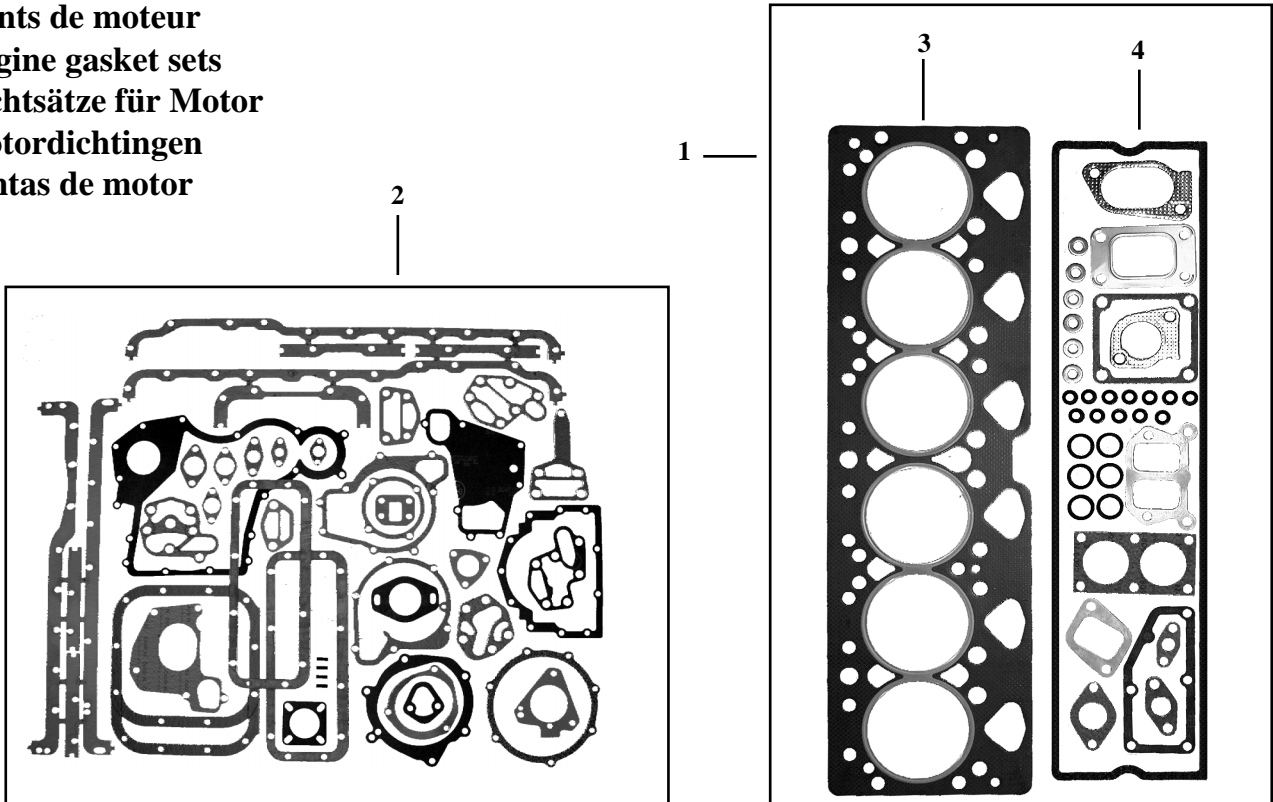

	1	2	3	4
	<b>Pochette rodage</b> <b>Top gaskets</b> <b>Kopfdichtsatz</b> <b>Kopset</b> <b>Kit juntas sup.</b>	<b>Pochette compl.</b> <b>Bottom gaskets</b> <b>Dichtsatz (Unten)</b> <b>Carterset</b> <b>Kit juntas inf.</b>	<b>Joint de culasse</b> <b>Cyl. head gasket</b> <b>Kopfdichtung</b> <b>Koppakking</b> <b>Junta culata</b>	<b>Joint cache soupapes</b> <b>Rocker gasket</b> <b>Ventildeckeldichtung</b> <b>Kleppendecksel-pakking</b> <b>Junta tapa de balancines</b>
Perkins 4.40 & T. 4.40	<b>30/71-90</b> (3638709M91, U5LT0178)	<b>30/72-90</b> (3640515M91, U5LB0151)	<b>30/73-90</b> (3641865M1, 3681E025)	<b>30/74-90</b> (3640094M1, 3681A021)
Perkins 6.60 & T6.60	<b>30/71-91</b> (3638697M91, U5LT0179)	<b>30/72-91</b> (4222229M91, U5LB0153)	<b>30/73-91</b> (3640916M1, 3681H205)	<b>30/74-91</b> (748329M1, 3681C001)

Les références des pièces sont indicatives.  
 Nos pièces ne sont pas d'origine.



**"THE RELIABLE SERVICE"**



Part numbers are quoted for reference purposes only.  
 Our parts and accessories are not original.

# PERKINS "1000"

Soupapes et pièces connexes

Valves & cylinder head parts

Ventile & Einzelteile

Cilinderkop onderdelen

Repuestos para válvulas y culatas

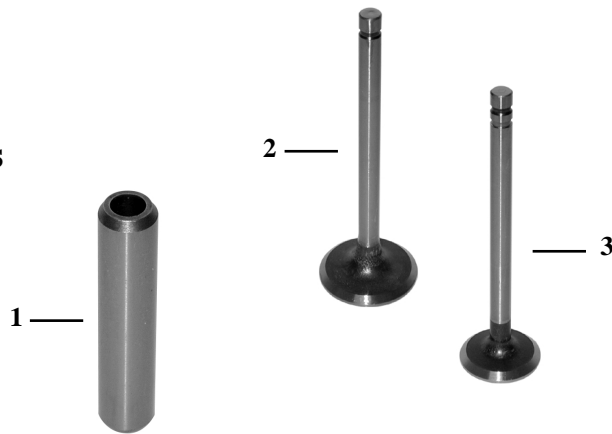

	1	2	3	
	<b>Guide d'admission</b> <b>Inlet guide</b> <b>Einlassventilführung</b> <b>Kleppgeleider</b> <b>Guía admisión</b>	<b>Guide d'échappement</b> <b>Outlet guide</b> <b>Auslassventilführung</b> <b>Kleppgeleider</b> <b>Guía escape</b>	<b>Soupape d'admission</b> <b>Inlet valve</b> <b>Einlassventil</b> <b>Inlaatklep</b> <b>Válvula admisión</b>	<b>Soupape d'échappement</b> <b>Exhaust valve</b> <b>Auslassventil</b> <b>Uitlaatklep</b> <b>Válvula escape</b>
MF3075, 3120, 8937 MF3125 (⇔ U556220X) MF3635, 3645, 3655 MF4245, 4255 MF6130, 6140, 6150 MF6180 (⇔ F017008) MF6190 MF8110 MF8120 (⇔ F044008) MF8130	<b>30/41-17</b> (3637056M1, 3343F002)	<b>30/41-18</b> (748420M1, 3343J002)	<b>30/42-39</b> (3640597M1, 3142L072)	<b>30/43-26</b> (748309M1, 3142A051)
MF396, 399, 3085, 3115 MF3125 (U556220X ⇔) MF3635, 4260, 4270 MF4225, 4235, 4240 MF6110, 6120, 6160 MF6170 (⇔ F014037)			<b>30/42-38</b> (748413M1, 3142L051)	

Clavette  
Cotter  
Ventilkeile  
Kleppspieen  
Cono válvula

**30/46-2**

(736453M1, 33173108)



Perkins "1000"

Joint siège Adm./Ech.  
Inlet/Outlet seal  
Ring Einlassventil/Auslassventil  
Inlaatklepzitting/Uitlaatklepzitting  
Retén

**30/47-1**

(3637041M1, 33817125)

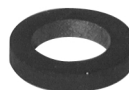

Perkins "1000"

Les références des pièces sont indicatives.  
Nos pièces ne sont pas d'origine.

Part numbers are quoted for reference purposes only.  
Our parts and accessories are not original.



# TRACPIECES

## bepco tractor parts

### PRODUCT NEWS-SHEET

PAGE : N° 7048

DATE : 12/99

# PERKINS "1000"

**Pistons, jeux de segments & Chemises / Pistons, ring sets & liners**  
**Kolben, Buchsen und Ringe / Zuigers, zuigerveren & cilinderbussen**  
**Pistones, juegos de anillos, y camisas**

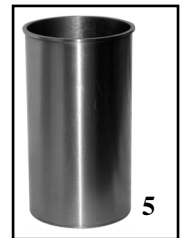
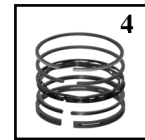
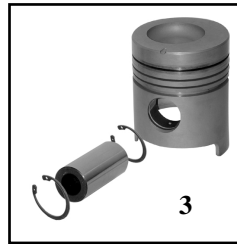
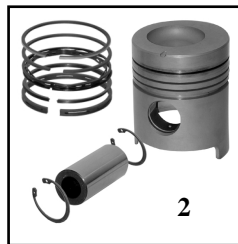
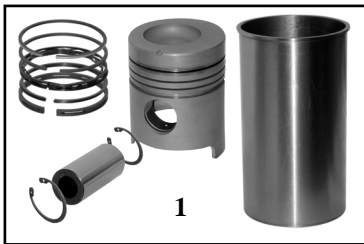

	1	2	3	4	5	
	Jeu Kit set Satz Set Juego	Piston avec segments Piston with rings Kolben mit Ringe Zuiger & zuigerveren Pistón con aros	Piston sans segments Piston less rings Kolben ohne Ringe Zuiger zonder zuigerveren Pistón sin aros	Jeu segments Ring set Satz Kolbenringe Zuigerverenset Juego de segmentos	Chemise finie Finished liner Buchse Afgewerkte cilinderbus Camisa terminada	Chemise semi-finie Semi liner Buchse (halbfertig) Bus half-afgewerkt Camisa semi
MF396, 399, 3085, 3095, 3115	30/31-109	30/32-109	30/33-109 (3638989M91, U5LL0015, 4222706M91)	30/34-110 (3637033M91, 4181A019)	30/35-108 (748216M1, 3135X042)	30/36-108 (748215M1, 3135X041)
MF6160, 6170 (⇔ U593765A)						
MF3075, 8937 MF3120, 3125, 3635, 3645, 3655 MF4245, 4255, 4265 MF6130, 6140, 6150 MF6180, 6190 (⇔ F017008) MF8110, 8120, 8130 (⇔ F044008)	30/31-108	30/32-108	30/33-108 (3638460M91, U5LL0014, 3640593M91)	30/34-108 (3641316M91, 4181A026)		
MF4260, 4270						
MF6160, 6170 (U593766A ⇔)						
MF4235 MF4245, 4255 (Low & High grades)				30/34-108 (3641316M91, 4181A026)		

	30/33-108	30/33-109
Hauteur de compression (mm) Compression height (mm) Kompressionshöhe (mm) Compressiehoogte (mm) Altura compresión (mm)	A	70.02
Profondeur chambre de combustion (mm) Combustion bowl depth (mm) Brennkammerntiefe (mm) Diepte verbrandingskamer (mm) Profundidad cámara de combustión (mm)	B	19.48
Hauteur totale (mm) Overall length (mm) Gesamthöhe (mm) Totale hoogte (mm) Longitud total (mm)	D	108.06

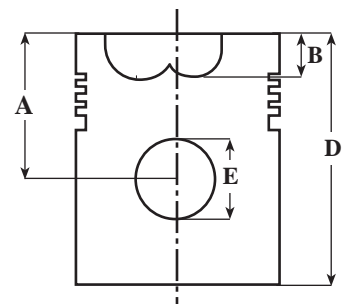
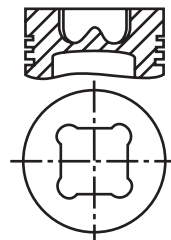

Les références des pièces sont indicatives.  
Nos pièces ne sont pas d'origine.

Part numbers are quoted for reference purposes only.  
Our parts and accessories are not original.



**"THE RELIABLE SERVICE"**



# PERKINS "1000"



## Caractéristiques techniques

### Technical data

### Technische Daten

### Kenmerken

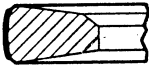
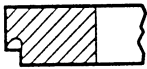
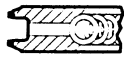
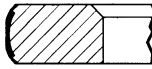
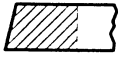
### Datos técnicos

30/34-108	Trapézoidal bilatéral chromé chanfrein intérieur haut Chrome plated keystone internally bevelled top Kolbenring, trapezförmig, verchromt, mit abgesetzter TOP-Kante Trapezium dubbelzijdig verchromd met aafschuining Trapezoidal dos caras con bisel superior (Cromado exterior)		CK3 : 3.500
	Bec d'angle Napier-externally stepped bottom with single hook Abgestufter Kolbenring Uitsparing aan de onderzijde Tipo «Napier» o «Pico de águila»		N1 : 2.500
	Chromé chanfreiné avec ressort hélicoidal Chrome plated bevelled edge with helical coil spring Ölabstreifring, verchromt, mit Spannfeder Met schuine gechromeerde kant en spiraalvormige veer Cromado y rebajado con muelle helicoidal		CBEH : 4.000
30/34-110	Portée bombé molybdène chanfrein intérieur en haut Molybdenum coated barrel faced internally bevelled top Gewölbt molybdänbeschichtet mit oben abgesetzter TOP-Kante Molybdeen gecoatet met afgeschuinde top Recubrimiento exterior de molibdeno, bisel interno superior		MR3 : 2.500
	Portée conique Taper faced plain Kompressionsring (einfach) Conisch dragend Exteriormente cónico		T1 : 2.500
	Chromé chanfreiné avec ressort hélicoidal Chrome plated bevelled edge with helical coil spring Ölabstreifring, verchromt, mit Spannfeder Met schuine gechromeerde kant en spiraalvormige veer Cromado y rebajado con muelle helicoidal		CBEH : 4.000

Alésage (mm) Nominal bore diameter (mm) Bohrung (mm) Boring (mm) Díametro pistón	A	30/35-108	100.00
Diamètre extérieur (mm) Outside diameter (mm) Aussendurchmesser (mm) Buitendiameter (mm) Díametro exterior (mm)	B		104.33
Hauteur totale (mm) Overall length (mm) Gesamthöhe (mm) Totale hoogte (mm) Longitud total (mm)	C		226.44
Diamètre colorette (mm) Flange diameter (mm) Durchmesser Kragen (mm) Diameter v/d kraag (mm) Díametro pestaña (mm.)	D		107.44
Colorette (mm) Flange width (mm) Anschlagflansch Bundhöhe Rand Anchura pestaña	E		3.86

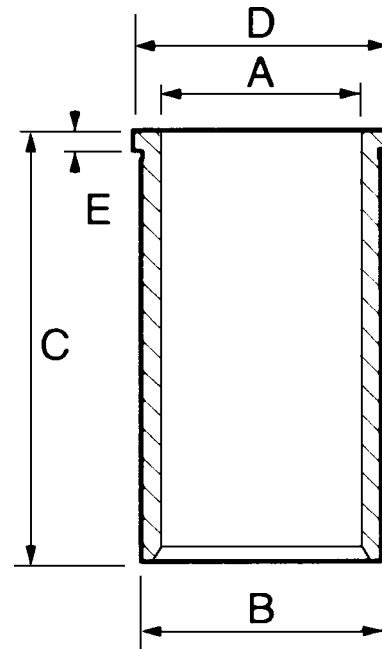

Les références des pièces sont indicatives.  
Nos pièces ne sont pas d'origine.

Part numbers are quoted for reference purposes only.  
Our parts and accessories are not original.



# TRACPIECES

## bepco tractor parts

### PRODUCT NEWS-SHEET

PAGE : N° 7049

DATE : 12/99

# PERKINS "1000"

Pompe d'alimentation et pièces connexes

Fuel pump & parts

Kraftstoffförderpumpe & Einzelteile

Opvoerpomp & onderdelen

Bomba gas-oil y piezas relacionadas

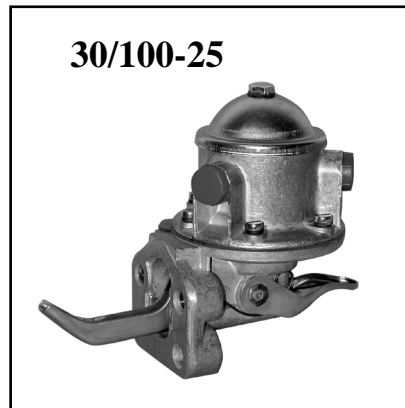

	Pompe d'alimentation Fuel pump Kraftstoffförderpumpe Opvoerpomp Bomba gas-oil	OEM	Jeu de réparation Repair kit Reparatursatz Revisieset Juego de reparación	OEM
MF396 MF399, 699, 3085, 3095, 3115, 3120, MF3125, 3635, 3645, 3655	30/100-25	4222105M91 ULPK0002	30/101-31	3641855M91 26412505 4222219M91
MF3075, 8937	30/100-32	4222106M91 ULPK0005	30/101-10	1896434M91 26410087 4222326M91
MF4225, 4235, 4240				
MF4245, 4255, 4265				
MF4260, 4270	30/100-25	4222105M91 ULPK0002	30/101-31	3641855M91 26412505 4222219M91
MF4270				
MF6110, 6120, 6130, 6140, 6150	30/100-32	4222106M91 ULPK0005	30/101-10	1896434M91 26410087 4222326M91
MF6160, 6170, 6180, 6190	30/100-25	4222105M91 ULPK0002	30/101-31	3641855M91 26412505 4222219M91
MF8110, 8120, 8130				

Les références des pièces sont indicatives.  
Nos pièces ne sont pas d'origine.



**"THE RELIABLE SERVICE"**



Part numbers are quoted for reference purposes only.  
Our parts and accessories are not original.

# PERKINS "1000"

Pompe à eau et pièces connexes  
 Water pump & parts  
 Wasserpumpe & Einzelteile  
 Waterpomp & onderdelen  
 Bomba agua y piezas relacionadas



	Pompe à eau Water pump Wasserpumpe Waterpomp Bomba agua	OEM	Jeu de réparation Repair kit Reparatursatz Revisieset Juego de reparación	
6130, 6140, 6150 8937	<b>30/130-90</b>	U5MW0144 3641869M91 4223566M91	<b>30/131-90</b> U7LW0071 U7LW0076 3637615M91	Axe / Axe / Welle Pen / Eje Ø 16x30x16
396, 399, 3085, 3095, 3115, 3120, 3125, 3635, 3645, 3655, 4260, 4270, 6160, 6170, 6180, 6190, 8110, 8120, 8130	<b>30/130-91</b>	3641860M91 3638694M91 4222028M91 U5MW0092	<b>30/131-91</b> U7LW0087 4222052M91	Axe / Axe / Welle Pen / Eje Ø 16x38x19

**Thermostat**  
**Thermostat**  
**Thermostat**  
**Thermostaat**  
**Termostato**



**30/143-18**

(1447384M1, 2485613)



3075, 8937, 396, 399, 3085, 3095, 3115, 3120, 3125, 3635,  
 3645, 3655, 4225, 4235, 4245, 4255, 4265, 4270,  
 4240, 6110, 6120, 6130, 6140, 6150, 6160, 6170, 6180,  
 6190, 8110, 8120, 8130

Les références des pièces sont indicatives.  
 Nos pièces ne sont pas d'origine.

Part numbers are quoted for reference purposes only.  
 Our parts and accessories are not original.





# TRACPIECES

## bepco tractor parts

### PRODUCT NEWS-SHEET

PAGE : N° 7050

DATE : 12/99

# PERKINS "1000"

## Filtration / Filters / Filter / Filters / Filtros

	Air / Air Luftfilter / Luchtfiter / Aire		Huile Oil Ölfilter Oliefilter Aceite	Combustible Fuel Kraftstoff-Filter Brandstofffilter Combustible	Hydraulique Hydraulic Hydraulik-Filter Hydrauliekfilter Hidráulico
	Ext. / Out. Außen / Buiten Exterior	Int. / Inn. Innen / Binnen Interno			
396	<b>60/161-23</b> (03595500M1)	<b>60/162-23</b> (03595501M1)	<b>60/97-3</b> (267/F) (1447031M1)	<b>60/111-5</b> (M.1851890) (CAV 7111/296) (836218M91, 3405418M1) 2 x = <b>60/111-3</b> (1087/PK) (Repl. CAV 296) 2 x (836218M91, 3405418M1)	<b>60/569-1</b> (03595175M1) Avec pompe double With tandem pump Mit Tandempumpe Met dubbele pomp Con bomba doble Direction assistée Power steering Lenkungsfilter Stuurbekrachtiging Dirección asistida  <b>60/625-2</b> (M.1870199) Relevage / Lift Kraftheber Lift / Elevación  ou / or / oder / of / o  <b>60/625-4</b> (025015M91) Avec pompe double With tandem pump Mit Tandempumpe Met dubbele pomp Con bomba doble Relevage / Lift Kraftheber Lift / Elevación
399	<b>60/158-9</b> Filtre complet à bain d'huile Complete oil bath filter Ölbadfilter komplett Komplete Oliebadfilter Filtro completo en baño de aceite  ou / or / oder / of / o  <b>60/161-23</b> (03595500M1) Au-dessus du capot Over bonnet Auf der Motorhaube Boven op motorkap Encima del capó  <b>60/161-24</b> (03595503M1) En-dessous du capot Under bonnet Unter der Motorhaube Onder de motorkap Debajo del capó	<b>60/159-9</b> Elément Element Einsatz Inzet Elemento  <b>60/162-23</b> (03595501M1)   <b>60/162-23</b> (03595501M1)			
3075	<b>60/161-25</b> (M.1062501) (1062501M1)	<b>60/162-25</b> (P.2651/0228) (1093683M92)	<b>60/97-2</b> (599AR/F) Ht. / Ht. H. / H. / Altura 142 mm (1447048M1)	<b>60/111-63</b> (7176/496) (CAV 496) (3638291M1) = <b>60/111-25</b> (5006/F) (Repl. CAV 496) (3638291M1)	<b>60/625-5</b> (03581032M2) A visser / Spin on Aufschraub./ Geschroefd Roscado Ht. / Ht. / H. / H. / Altura 165mm (↔ S95020)
3085, 3095, 3115 3120			<b>60/97-3</b> (267/F) (1447031M1)	<b>60/111-63</b> (7176/496) (CAV 496) (3638291M1) = <b>60/111-25</b> (5006/F) (Repl. CAV 496) (3638291M1)  ou / or / oder / of / o	<b>60/625-6</b> (03616579M1) A visser / Spin on Aufschraub./ Geschroefd Roscado Ht. / Ht. / H. / H. / Altura 98mm (S95020 ↔)
3125	<b>60/161-27</b> (03385733M1)	<b>60/162-27</b> (03385734M1)		<b>60/111-5</b> (M.1851890) (CAV 7111/296) (836218M91, 3405418M1) 2 x = <b>60/111-3</b> (1087/PK) (Repl. CAV 296) 2 x (836218M91, 3405418M1)	<b>60/240-41</b> (03619594M1) Crépine / Strainer Einsatz/ Aanzuigfilter Filtro de rejilla  <b>60/574-7</b> (03615949M1) Direction assistée Power steering Lenkungsfilter Stuurbekrachtiging Dirección asistida

Les références des pièces sont indicatives.  
Nos pièces ne sont pas d'origine.



**"THE RELIABLE SERVICE"**



Part numbers are quoted for reference purposes only.  
Our parts and accessories are not original.

# PERKINS "1000"

## Filtration / Filters / Filter / Filters / Filtros

	Air / Air Luftfilter / Luchtfiter / Aire		Huile Oil Ölfilter Oliefilter Aceite	Combustible Fuel Kraftstoff-Filter Brandstofffilter Combustible	Hydraulique Hydraulic Hydraulik-Filter Hydrauliekfilter Hidráulico
	Ext. / Out. Außen / Buiten Exterior	Int. / Inn. Innen / Binnen Interno			
3635, 3645, 3655	<b>60/161-27</b> (03385733M1)	<b>60/162-27</b> (03385734M1)	<b>60/97-2</b> (599AR/F) (1447048M1)	<b>60/111-5</b> (M.1851890) (CAV 7111/296) (836218M91, 3405418M1) = <b>60/111-3</b> (1087/PK) (Repl. CAV 296) (836218M91, 3405418M1) ou / or / oder / of / o <b>60/111-63</b> (7176/496) (CAV 496) (3638291M1) = <b>60/111-25</b> (5006/F) (Repl. CAV 496) (3638291M1)	<b>60/625-7</b> (03386701M1) Relevage / Lift Kraftheber Lift / Elevación
4225, 4235	<b>60/161-118</b> (3901462M1) 305mm  <b>60/161-119</b> (3901464M1) 345mm	<b>60/162-118</b> (3901463M1) 319,3mm  <b>60/162-119</b> (3901465M1) 359,3mm		<b>60/111-63</b> (7176/496) (CAV 496) (3638291M1) = <b>60/111-25</b> (5006/F) (Repl. CAV 496) (3638291M1)	
4245, 4255, 4265	<b>60/161-119</b> (3901464M1) 345mm  <b>60/161-120</b> (3901475M1) 360mm	<b>60/162-119</b> (3901465M1) 359,3mm  <b>60/162-120</b> (3901476M1) 373,8mm	<b>60/97-3</b> (599AR/F) (1447031M1)	<b>60/111-5</b> (M.1851890) (CAV 7111/296) (836218M91, 3405418M1) = <b>60/111-3</b> (1087/PK) (Repl. CAV 296) (836218M91, 3405418M1)	
4260, 4270	<b>60/161-120</b> (3901475M1) 360mm  <b>60/161-121</b> (3901477M1) 385mm	<b>60/162-120</b> (3901476M1) 373,8mm  <b>60/162-121</b> (3901478M1) 398,5mm		<b>60/111-5</b> (M.1851890) (CAV 7111/296) (836218M91, 3405418M1) = <b>60/111-3</b> (1087/PK) (Repl. CAV 296) (836218M91, 3405418M1) 2 x	
6110 6120, 6130, 6140, 6150	<b>60/161-25</b> (M.1062501) (1062501M1)	<b>60/162-25</b> (P.2651/0228) (1093683M92)	<b>60/97-2</b> (599AR/F) (1447048M1)	<b>60/111-63</b> (7176/496) (CAV 496) (3638291M1) = <b>60/111-25</b> (5006/F) (Repl. CAV 496) (3638291M1)	<b>60/625-6</b> (03616579M1) A visser / Spin on Aufschraub- / Geschroefd Roscado Relevage / Lift Kraftheber Lift / Elevación
6160, 6170, 6180			<b>60/97-3</b> (267/F) (1447031M1) 2 x	<b>60/111-63</b> (7176/496) (CAV 496) (3638291M1) 2 x = <b>60/111-25</b> (5006/F) (Repl. CAV 496) (3638291M1) 2 x	<b>60/240-40</b> (03618662M1) Crépine / Strainer Einsatz/ Aanzuigfilter Filtro de rejilla

Les références des pièces sont indicatives.  
Nos pièces ne sont pas d'origine.

Part numbers are quoted for reference purposes only.  
Our parts and accessories are not original.



# TRACPIECES

## bepco tractor parts

### PRODUCT NEWS-SHEET

PAGE : N° 7053

DATE : 12/99

# PERKINS "1000"

## Filtration / Filters / Filter / Filters / Filtros

	Air / Air Luftfilter / Luchtfiter / Aire		Huile Oil Ölfilter Olielfiter Aceite	Combustible Fuel Kraftstoff-Filter Brandstofffilter Combustible	Hydraulique Hydraulic Hydraulik-Filter Hydrauliekfilter Hidráulico
	Ext. / Out. Außen / Buiten Exterior	Int. / Inn. Innen / Binnen Interno			
6190	<b>60/161-27</b> (03385733M1)	<b>60/162-27</b> (03385734M1)	<b>60/97-3</b> (267/F) (1447031M1)	<b>60/111-63</b> (7176/496) (CAV 496) (3638291M1) 2 x = <b>60/111-25</b> (5006/F) (Repl. CAV 496) (3638291M1) 2 x	<b>60/625-7</b> (03386701M1) A visser / Spin on Aufschraub./ Geschroefd Roscado  ou / or / oder / of / o  <b>60/240-40</b> (03618662M1) Crépine / Strainer Einsatz/ Aanzuigfilter Filtro de rejilla
8110, 8120, 8130, 8140, 8150, 8160	<b>60/161-27</b> (03385733M1)	<b>60/162-27</b> (03385734M1)	<b>60/97-3</b> (267/F) (1447031M1) 2 x	<b>60/111-63</b> (7176/496) (CAV 496) (3638291M1) 2 x = <b>60/111-25</b> (5006/F) (Repl. CAV 496) (3638291M1) 2 x	<b>60/625-7</b> (03386701M1) A visser / Spin on Aufschraub./ Geschroefd Roscado  <b>60/625-9</b> (03619712M1) A visser / Spin on Aufschraub./ Geschroefd Roscado <b>LOAD SENSING</b>  ou / or / oder / of / o  <b>60/240-40</b> (03618662M1) Crépine / Strainer Einsatz/ Aanzuigfilter Filtro de rejilla
8937					

Les références des pièces sont indicatives.  
Nos pièces ne sont pas d'origine.



**"THE RELIABLE SERVICE"**



Part numbers are quoted for reference purposes only.  
Our parts and accessories are not original.

# PERKINS "1000"

Les références des pièces sont indicatives.  
Nos pièces ne sont pas d'origine.

*Part numbers are quoted for reference purposes only.  
Our parts and accessories are not original.*

NOUVEAUTES

PERKINS  
PIECES ADAPTABLES

Page P-3

ENSEMBLES COMPLETS DE REVISION

\*

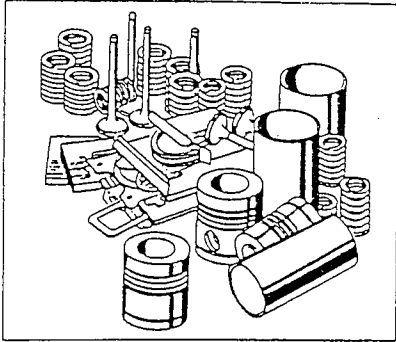

Ajouter:

- P.30/B.3001 - A3.152 (chemises chromées) jusque n°1846219
- P.30/B.3002 - A3.152 (chemises chromées) à partir n°1846220
- P.30/B.3003 - A3.152 (chemises fonte)
- P.30/B.3026 - 4.318 (Tract. MF.285,595,1080, 1085)
- P.30/B.3027 - 4.318-2 (Tract. MF.298,698)
- P.30/B.3175T - AT.4.236 (Tract. MF.390T, 398 (Turbo)
- P.30/B.3174 - AT.4.236 (Tract. MF.3065, 3070 (Turbo)

DISTRIBUTION

Précisions:

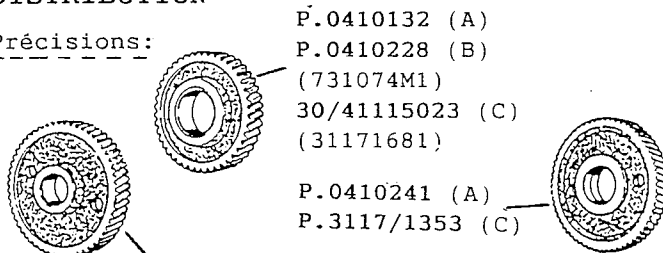

- P.0410132 (A)
- P.0410228 (B) (731074M1)
- 30/41115023 (C) (31171681)
- P.0410241 (A)
- P.3117/1353 (C)

- P.3116/4362 (A) Supérieur
- P.0410227 (B) Inférieur
- 30/41115023 (C)

- (A) 3.152, D3.152
- (B) 4.192, 4.203, D.4.203
- (C) 4.212, 4.236, 4.248

P.3113/4132 (31134164)  
(4A.212, 4A.236, 4A.248)

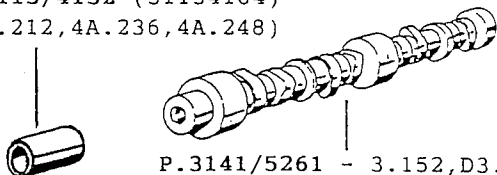

- P.3141/5261 - 3.152, D3.152
- P.3141/5214 - 4.192, 4.203, D4.203
- P.3141/5321 - 4.212, 4.236, 4.248
- P.3141/6205 - 6.354, 6.354-4

\*

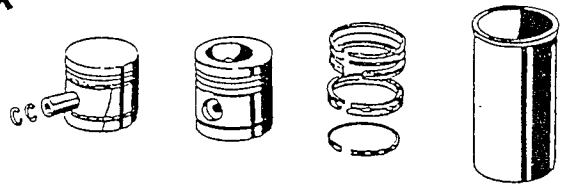

CHEMISE, PISTON, SEGMENTS  
POUR MOTEUR AT.4.236

Monté sur MF.390T, 398, MF.3065,3070:

- 30/3135X032 - (3637032M1) Chemise finie
- P.50022 - (U5LP.0022,3637360M91) Piston
- 0747602M91 - (41158145) Jeu segments
- 03637361M91 - (U5LT.0046) Pochette joints rodage
- P.50037 - Pochette joints complémentaire (3637600M91)

CHEMISE, PISTON, SEGMENTS  
POUR MOTEUR AT.4.236

Monté sur MF.698T:

- 30/31358394 - (744948M1) Chemise finie
- 03637754M91 - (U5LP.0006) Piston
- 0747602M91 - (41158145) jeu segments
- P.3681/2341 - (746342M1) Joint culasse
- P.3681/1114 - (746714M1) Joint c/soupapes
- P.92440 - Pochette joint complémentaire (747191M91)

Page P-5

JOINTS DE PALIER ARRIERE  
DU VILEBREQUIN

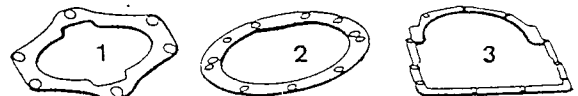

- 1. P.3681/7134 - A3.152, AD3.152 avec palier joint tressé
- 2. P.3382/6111 - AD3.152, AD4.203 avec palier joint à lèvres
- 3. P.3681/7136 - Avec palier joint tressé
- P.3681/7157 - Avec palier joint lèvres

- A4.212,
- A4.236,
- A4.248,
- A6.354

Non original replacements

**PERKINS (suite)**

Page P-6

**POMPES A HUILE DE MOTEURS**

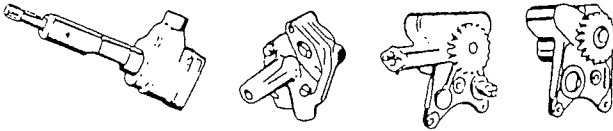

- P.4131/4089 - 4.107  
(41314092)
- P.4131/4078 - 3.152, D3.152, AT.3.1524  
(41314178, 41314187)
- P.4131/4087B - 4.203, D4.203  
(41314164)
- P.4131/4054 - 4.212, 4.236, 4.248  
(Moteurs sans équilibreur)
- P.4131/4113 - 4.318
- P.4131/4131 - 6.354  
(Axe de 216 mm.)
- P.4131/4067 - 6.354, 6.354-1,  
(Axe de 280 mm.) T6.354-1
- P.4132/F.015 - 6.354-4 (390, 3080, 3090)
- P.4132/F.016 - T6.354-2/3 et 4

**EQUILIBREURS (Tract. Massey-Ferguson)**

- P.4173/3066 (41733082)
- P.4111/K.051-053-055-057

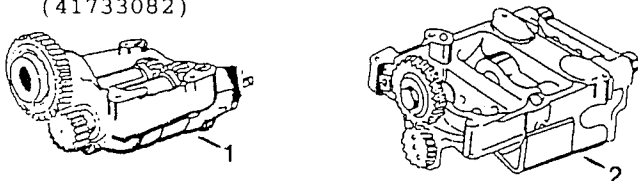

1er modèle (Montage 4 boulons)      2ème modèle (Montage 6 boulons)

- 1. P.4173/3066 - Ensemble équilibreur  
(41733082) (Moteurs 4A.236, 4A.248 équipés)

**Pièces de rechange pour équilibreur réf.1.:**

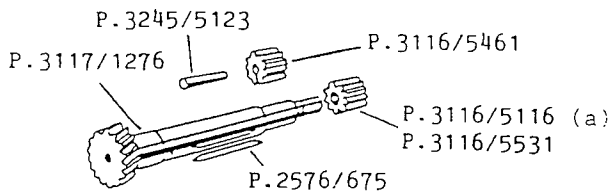

- MF.B.1244 - Kit comprenant:  
P.3117/1276 + P.3245/5123 + P.3116/5531  
P.2576/675 + P.3116/5461
- (a) P.3116/5116, pignon pour arbre ancien n° 31171272 (pas compris dans le kit MF.B.1244)

- (A) MF.A.89/12 - Paire de roulements (2558375 + 2558371)
- (A) MF.A.89/34 - Paire de roulements (255718 + 2557176)



- 2. P.4111/K051 - Equilibreur, A4.236, A4.248 (MF.365, 375 → n°U171963P 3050, 3060)
- P.4111/K055 - Equilibreur, A4.236, A4.248 (MF.362, 365, 375, U171963P →, 390)
- P.4111/K053 - Equilibreur, AT4.236 (398 → U171963P, 3065, 3070)
- P.4111/K057 - Equilibreur, AT4.236 (390T, 398 U171964P →)

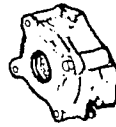

P.4132/F.041 - Pompe à l'huile pour équilibreurs:  
P.4111/K051/053/055/057 (Remplace P.4132/F021)

**COLLECTEURS D'ECHAPPEMENT**

Précisions:



**MOTEURS 3 CYLINDRES**

- 1. 30/37781251 - A3.144, A3.152 (MF.35, MF.133)
- 2. 30/37781341 - AD3.152 (MF.135) Coude 180°
- 30/37781571 - AD3.152 (MF.135, MF.148, MF.230 (740221M1) MF.240, MF.250, MF.350) Coude 90°

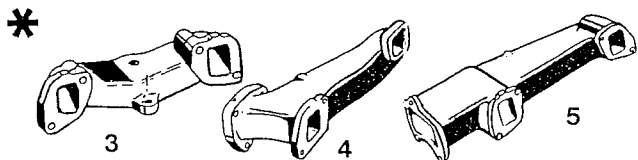

**MOTEURS 4 CYLINDRES 4A.212-236-248**

- 3. 30/37781333 - 4A.212 (MF.165), 4A.236 (MF.175) 4A.248 (MF.178 → UA.36359)
- 4. 30/37781781 - 4A.212 (MF.165), 4A.236 (MF.168) 4A.248 (MF.178, UA.36360 →) 4A.236 (MF.565, 575) avec (échappement à côté du capot)
- 5. 30/37781051 - 4A.236 (MF.265, 275, 565, 575) 4A.248 (MF.285, 290, 590) avec (échappement à travers du capot)

**Non original replacements**

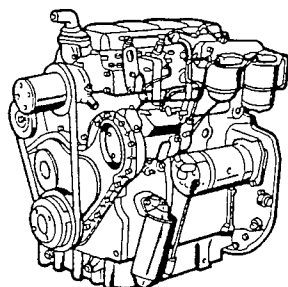

**LISTE DES APPLICATIONS PRINCIPALES**  
(Engins agricoles, industriels et de manutention)

**ATTENTION:** Les données ci-dessous sont générales. Il existe de nombreuses variantes selon les équipements, notamment au niveau des cylindres où des chemises chromées ont parfois été utilisées. Dès lors, il est conseillé de procéder à une identification correcte du moteur avant de commander des pièces.

APPLICATIONS	TYPE MOTEUR	APPLICATIONS	TYPE MOTEUR	APPLICATIONS	TYPE MOTEUR
<b>ARBOS</b> (Italia) Mois. batteuse	T6.354-4	<b>CLARK</b> (suite) CY30,CY40,CY50 Fork Lift, CY 40/60 DG50, DCY50, DC30 Fork Lift DC40,DCY40 40 D/Y 40D Fork Lift 45 D/Y 45D 50 D/Y 50D 55 D/Y 55D		<b>DRONNINGBORG</b> Mois. bat. D.1600, SP D.8000,MF.29	6.354 T6.354-4
<b>BERLIET-SAVIEM</b> GL.750,560K,610K 550K	6.354-2 4.236			<b>FENWICK</b> (France) Fork Lift D25P,D30P J.D.S.P.1000,1250, 1500 SDAP 205,255 J.1072 SD.3A,SD.3B	4.203 D4.203 4.108 D3.152 4.108 D3.152
<b>BOLINDER-MUNKTELL</b> D.430,T.430	D3.152			<b>GULDNER</b> SL.3.5 Fork Lift, SL.4,SL.7,SL.7C, SL.5/6 SL.10,SL.13 SL.3	4.236 6.354 3.152
<b>BOMBARDIER</b> S. carrier	4.236			<b>HANOMAG</b> Chargeur 911 Excavator 450E Pelle MF.33C NX.730 Loader Pelles 220,B.8	D3.152 6.354-4 6.354-4 4.108 4.248
<b>BOURGOIN</b> (France) Récolteur de maïs	4.236		4.203	<b>HESSTON</b> Récolteuses X.81, 6400,6500,6650	4.236
<b>BRAUD</b> (France) Mois. bat. 700 Vendangeur TO.23	T6.354-4 T4.236	C500Y 40D/DEX Fork Lift C500Y 45D C500Y 50D C500Y 55D C500YS 60D	4.203	<b>HYSTER</b> H60B,H60C KE Grue H40F Fork Lift H60-80C Fork Lift T C500Y-40-560 Fork Lift, H60-80E Fork Lift S70B Fork Lift S80B S100B H30H,H40H,H50H, H60H,H70C,H80C 8-10,000Lbs. Hyster Fork Lift T1-1034 Fork Lift C350-C530 Compactor P60-P80A Fork Lift	4.236 6.354 3.152
<b>CARRARO</b> (Italia) Tract. 48.2,48.4 Tract. 58.2,58.4 Tract. séries 600, 700 et 800	D3.152 D4.203 4.236	CTAD 20,30 40,50 Tow Tractor IT 50-60 Fork Lift 60 D/Y 60D Fork Lift 70 D/Y 70D 80 D/Y 80D CY60,CY70,CY80B Fork Lift C100,C120 Fork Lift C500Y 60D Fork Lift C500Y 70D C500Y 80D C500Y 100D C500Y 110D C500Y 120D	4.236		
<b>CATERPILLAR</b> Fork Lift V160/300 Fork Lift 660P Tract. V.100,140, 140C Fork Lift 4-6000, 6-8000,VC60-C	6.354 4.236 4.236 4.236				
<b>CLAAS-PATENT</b> Modèle 30 Dominador 66,86 Matador Mercator Mercury Dominador 38,58	4.236 6.354-4 6-354 4.248 4.236 4.236				
<b>CLARK</b> C500Y 20/Y 20D Fork Lift, C500Y 25/Y 25D C500Y 30/Y 30D H500Y 30 DEY C500Y 20/Y 20D Fork lift C500Y 25/Y 25D C500Y 30/Y 30D H500Y 30 DEX,H.500	3.152 4.108	45B Tractor,C500, CY160-300 Fork Lift 16000-30000 LB Fork Lift <b>COVENTRY CLIMAX</b> DA.2.0,2.5,3.0 Fork Lift 3000-6000 LB Fork Lift	6.354 6.354-4 D4.203 4.203		

**Non original replacements**

à suivre →

APPLICATIONS	TYPE MOTEUR	APPLICATIONS	TYPE MOTEUR	APPLICATIONS	TYPE MOTEUR
S60-100 Fork Lift		<b>MASSEY-FERGUSON</b>		MF.350,400	4.248
C300 Compactor		<b>1. Agriculture</b>		MF.450C Excavator	6.354-1
H110-150 Fork Lift		MF.30,130,825	4.107	MF.450E Excavator	6.354-4
S125A Fork Lift		MF.35/3 cyl.,35X,		MF.2203,2205	D3.152
Truck,S150A,		37	3.152	MF.3165,3303,3305	4.203
H110F,H130F,H150F	4.236	133 (Export)France	3.144	MF.3165R	4.212
S30A,S40C Fork		135,140,142,145,		MF.3366	4.236
Lift,S50C	3.152	148,152		MF.4000 Fork Lift	D3.152
H165E Fork Lift,		230,235,240,245,		MF.6000 Fork Lift	4.236
H150E Fork Lift,		250,255			
H180E,H250 Fork		550	D3.152	<b>MASSEY-FERGUSON (Landini)</b>	
Lift,H200E,H200ES		MF.65 (1ère série)	4.192	MF.154	D3.152
H225E,H250E,		MF.65 (2ème série)	4.203	MF.174,MF.184	4.236
H300A		155-158	D4.203	MF.194,MF.294	4.248
P125A,P150A		165 (FR.) certains	4/203	MF.254,MF.274,	
P165A,P180A		165 (France),765	D4.203	MF.284	4.236
C550A	6.354	165 (England),		MF.1014	6.354-4
H150-275-300-350		165 MK3	4.212	MF.1114	6.354
Fork Lift	6.354-4	168,175	4.236	MF.1104	6.354-1
H20E,H25E,H30E		178,185,188	4.248	MF.1134	T6.354-4
Fork Lift	4.107	260,265,275,560,		MF.13000	6.354-4
<b>I.M.T</b>		565,575	4.236		
586/589	4.236	285,290,590,690	4.248	<b>MIAG</b>	
576/579	4.248	285,298,595,698,		DFG.20,25,30,35,40	4.203
<b>J.C.B. (J.Bamford)</b>		1080	4.318	<b>ORENSTEIN + KOPPEL</b>	
3CX,520	4.236	698T	T4.236	V.16,20,25,26,30	4.203
807 Excavator	6.354	699	6.354-4	<b>REFORMWERKE</b>	
806C Excavator	6.354-4	1100	6.354	Muli 45	D3.152
<b>LANDINI</b>		1200	6.354-1	<b>RENAULT-D.M.A.</b>	
R.4000	3/144	350	D3.152	N.71,D.30	3/144
R.4500	3.152	355,360	T3.152	Super 7D	3.152
R.5000,5500,5830	D3.152	365,375,3050	4.236	501-4	D3.152
R.50,R.6000	4.192	390,3060	4.248	601-4	D4.203
R.6000	4.203	398,3065,3070	T4.236	70-12,70-14	A.236
R.7000	D4.203	2620,2625,2640,		80-12,80-14	A.248
R.8000	4.236	2645	6.354-4	<b>SAMBRON</b>	
6500 (1ère version)	4.212	3080,3090,3610	6.354-4	A.34 Elévateur	D3.152
6500,6530,6550,		2680,2685,2720,		J.24T Elévateur	4.236
7500,7530,7550,		2725,3630	T6.354-4	<b>STEINBOCK</b>	
7580	4.236	<b>2. Industrie</b>		BFG,TFG.1D,DFG.4DR	4.236
8500,8550,8830	4.248	MF.20,20C,20D	D3.152	DFG.2C,DFG.2,5,	
R.9500	6.354-1	Industrial		DFG.2,5R	4.203
10000,11000,13000	6.354-4	MF.11 Chargeur,	4.248	<b>URSUS</b>	
12500	6.354-4	MF.22C	4.236	235 (3 cyl.)	D3.152
14500	T6.354-4	MF.31	D3.152	<b>VALMET</b>	
<b>LANSING BAGNALL</b>		MF.30B,30E	6.354-4	Tracteur	4.203
Fork Lift	4.236	MF.33C Chargeur	4.248	<b>VOLVO-BOLLINDERS</b>	
FODR 34 (6000 Lbs)	4.203	MF.33,MF.33B		T.500,P.300,P.827	
<b>LAVERDA</b>		MF.40B,50	D4.203	P.830,P.838,F.407	4.236
Mois. bat.	6.354	Industrial	6.354		
Mois. bat. M.92	4.236	MF.44	4.236		
<b>MANITOU</b>		MF.50,50B,50C,50D,	4.212		
MP.25P Elevateur	4.236	50E	D4.203		
		MF.50 Industrial,			
		MF.30			
		MF.302,304			

**Non original replacements**



**ENSEMBLES COMPLETS DE REVISION POUR MOTEURS D'ENGINS AGRICOLES ET INDUSTRIELS**

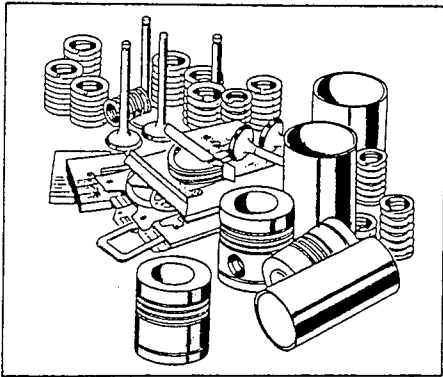

Chaque ensemble comprend:  
Pistons et segments, chemises, jeu de soupapes, ressorts et accessoires, bagues d'étanchéité, pochettes de joints, bagues et écrous de bielle.

- P. 30/B. 3004 - AD3.152 (1ère série)  
Soupapes angle 45° (A)
- P. 30/B. 3005 - AD3.152 (2ème série)  
Soupapes angle 45° (B)
- P. 30/B. 3006 - AD3.152 (3ème série)  
Soupapes angle 35° (C)
- P. 30/B. 3007 - AD3.152S (4ème série)  
Soupapes angle 35° (D)
- P. 30/B. 3014 - AD4.203 Inject. directe (E)
- P. 30/B. 3015 - AD4.203 Inject. directe (F)

- P. 30/B. 3016 - A4.212 (Pistons 4 segments)  
MF.165,50,50B
- P. 30/B. 3018 - A4.236 (Massey-Ferguson 168,175)
- P. 30/B. 3019 - A4.236 (Massey-Ferguson 265,275,565,  
575,675,30D,50D,50E,50H)
- P. 30/B. 3022 - A4.248 (Massey-Ferguson 178,185,188)
- P. 30/B. 3023 - A4.248 (Massey-Ferguson 290,590,690,  
50HX) (G)
- P. 30/B. 3024 - A4.248 (Massey-Ferguson 290,590,690,  
50HX) (H)

- (A) Massey-Ferguson 135 jusque n° 3910044DL
- (B) MF.135 depuis n° 3910045DL,230,235,240,245
- (C) Massey-Ferguson 135,230,235,240,245,20B,20D,  
20E,40
- (D) Massey-Ferguson 148,152,250,350,550
- (E) Massey-Ferguson 65,765(→29C1083),155,158,  
165,50
- (F) Massey-Ferguson 65,765(29C1084→),155,158,  
165,50
- (G) Piston 4 segments
- (H) Piston 3 segments

**ATTENTION:** Les ensembles ci-dessus contiennent des chemises finies en fonte (sauf 30/B.3022 qui est avec des chemises semi-finies).

Pour les montages avec chemises chromées ainsi que pour les moteurs non référenciés ci-dessus, il faut commander toutes les pièces séparément.

**JEUX DE SOUPAPES ET PIECES CONNEXES**

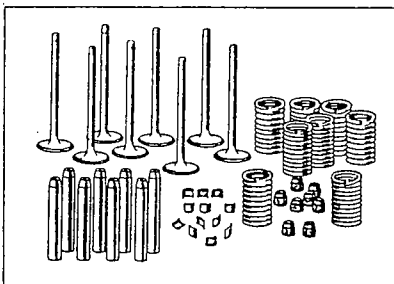

Chaque jeu comprend les pièces illustrées et qui sont nécessaires pour un moteur.

- P. 45/B. 3902 - 3.152
- P. 45/B. 3903 - D3.152 (Soupapes angle 45°)
- P. 45/B. 3904 - D3.152 (Soupapes angle 35°)
- P. 45/B. 3905 - T.3.152 (Turbo)
- P. 45/B. 3906 - 4.107,4.108
- P. 45/B. 3908 - 4.203
- P. 45/B. 3909 - D4.203
- P. 45/B. 3910 - 4.212,4.236,4.248 (A)
- P. 45/B. 3911 - 4.236 (B)
- P. 45/B. 3914 - 4.248 (C)
- P. 45/B. 3916 - 4.318
- (A) Massey-Ferguson 165,168,175,178,185,188,50
- (B) Massey-Ferguson 265,275,565,575,675,50,50D,50E
- (C) Massey-Ferguson 290,590,690,50HX

**COUVERCLE**

(Carter de distribution)

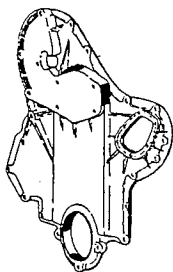

- P. 90039ZZ - 3A.152,D3.152,  
(A5FH.0245) T3.152
- P. 3716/1642 - 4A.212,4A.236,  
4A.248

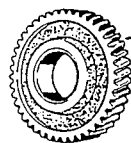

- P. 3116/4362 (A)
- P. 0410227 (B)
- 30/41115023 (C)

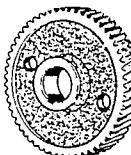

- P. 0410241 (A)
- P. 3117/1353 (C)

- P. 3116/4362 (A)
- P. 4111/5004 (B)
- 30/41115023 (C)

**DISTRIBUTION**

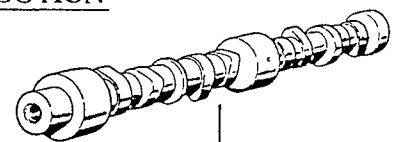

- P. 3141/5261 - 3.152,D3.152
- P. 3141/5214 - 4.192,4.203,D4.203
- P. 3141/5321 - 4.212,4.236,4.248
- P. 3141/6205 - 6.354,6.354-4

- (A) 3.152,D3.152
- (B) 4.192,4.203,D4.203
- (C) 4.212,4.236,4.248

**Non original replacements**

**CHEMISES, PISTONS, SEGMENTS**

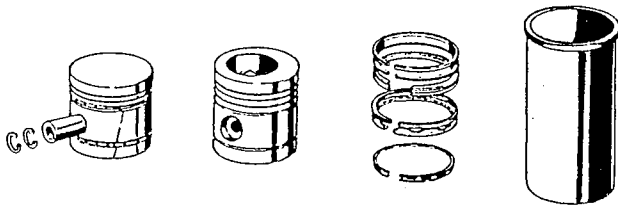

**ENSEMBLES 1 PISTON COMPLET AVEC SEGMENTS ET 1 CHEMISE:**

- P.4308K (U5MK0036) - 4.107
- P.82119 (U5MK0034) - D3.152, D4.203 avec chemise fonte

**PISTONS AVEC AXE (SANS SEGMENTS) COTE STD.**

- P.55275 - (Ø 88,93) - Avec segments. P3(TA), 3/144, 4.192, P.6, 6.288
- P.81512 - (Ø 91,49) - 3.152, 4.203, 6.305
- P.82111 - (Ø 91,49) - D3.152, D4.203 (68332) Injection directe
- P.89209 - (Ø 91,49) - D3.152S pour tract. (89214) MF.148, 250, 350, 550
- P.86721 - (Ø 98,47) - 4.212 (→UA.87004) 4 segments
- P.89206 - (Ø 98,47) - 4.212 (UA.87005→) 3 segments
- P.82878 - (Ø 98,47) - 4.236, tract. MF.168, 175
- 30/68301 - (Ø 98,47) - 4.236, tract. 265, 275 560, 565, 575, 675, 3050
- P.86740 - (Ø 98,47) - 6.354, 6.354-4
- P.50014 - (Ø 98,47) - 6.354-4
- P.68803 - (Ø 98,47) - T6.354-4 (86726)
- P.89207 - (Ø 101,05) - 4.248, MF.178, 185, 188
- P.50009 - (Ø 101,05) - 4.248S, MF.285, 290, 590 690, 390
- P.86716 - (Ø 114,3) - 4.318, MF.285, 595, 1080
- 30/68810 - (Ø 114,3) - 4.318, MF.298, 698

**CHEMISES DE CYLINDRE (COTE STD.):**

- P.0530002/F - Chemise fonte finie P3(TA), 3/144, 4.192, P.6, 6.288
- P.3135/8308 - Chemise chromée, 3.152, 4.203
- P.3135/8322 - Chemise fonte finie 3.152 (3135 8345) D3.152
- P.3135/8323 - Chemise semi-finie 4.203
- P.3135/8384 - Chemise semi-finie D4.203 Ø ext. 94,4mm
- P.3135/8116 - Chemise finie, 4.107
- P.3135/8341 - Chemise finie 4.212, 4.236 (3135 8441) 6.354, 6.354-2
- P.3135/8339 - Chemise semi-finie MF.165, 168
- 30/31358394 - Chemise finie 4.236, T6.354-1
- P.3135/8393 - Chemise MF.265, 275, 560, semi-finie 565, 575, 675, 3050
- 30/3135x032 - Chemise finie 4.236,
- 30/3135x031 - Chemise semi-finie MF.365, 375

**CHEMISES DE CYLINDRE (suite)**

- P.3135/8343 - Chemise semi-finie, 4.248 (MF.178, 185, 188→154480L)
- P.3135/8352 - Chemise finie (avec collerette) 4.248S
- P.3135/8346 - Chemise semi-finie (avec collerette) 4.248S (MF.285, 290, 590, 690)
- 30/3135x034 - Chemise finie 4.248S
- 30/3135x033 - Chemise semi-finie MF.390
- P.3135/8521 - Chemise finie 4.318
- (3135 8534) - Chemise semi-finie MF.285, 595, 1080

**JEUX DE SEGMENTS (COTE STD.) POUR UN CYLINDRE**

- P.82154 - (41158085) - 4.107
- P.84955 - (41158063) - P3(TA), 3/144, 4.192 P.6, 6.288
- P.82906 - (41158053) - 3.152, D3.152, 4.203 D4.203 (Chemises chromées)
- P.84957 - (41158057) - 3.152, D3.152, 4.203 D4.203 (Chemises fonte)
- P.86781 - (41158065) - D3.152 (MF.148, 250 550, 350)
- P.86753 - (41158044) - 4.212 (4 segments)
- P.86775 - (41158045) - 4.212 (3 segments)
- P.83388 - (41158041) - 4.236, 6.354
- P.86778 - (4181A009) - 4.248, 4.248S
- 30/41158022 - (41158022) - 4.248S (MF.285, 290 590, 690)
- P.86754 - (41158118) - 4.318 (MF.285, 595 1080)
- P.4115/8132 - 4.318 (MF.298, 698)
- 30/41158032 - 6.354-1, 6.354-4
- 30/41158005 - T6.354-4

**JEUX DE SEGMENTS SPECIAUX (1 CYL.):**

- P.84/PC.955 - P3(TA), 3/144, 4.192, P.6, 6.288
- P.82/PC.906 - Pour chemise chromée 3.152, D3.152
- P.84/PC.957 - Pour chemise fonte 4.203, D4.203
- P.86/PC.753 - 4.212 (4 segments)
- P.83/PC.388 - 4.236, 6.354
- P.86/PC.778 - 4.248, 4.248S

**ACCESSOIRES DE BLOC-MOTEUR**

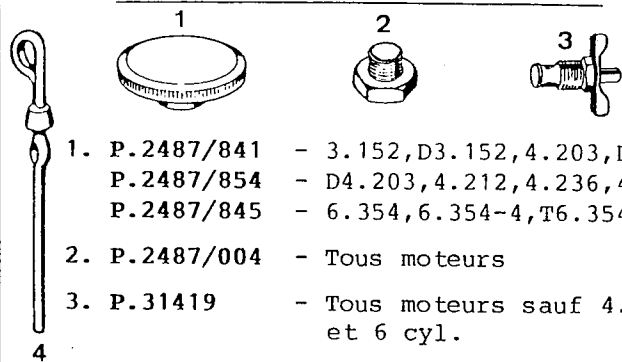

- 1. P.2487/841 - 3.152, D3.152, 4.203, D4.203
- P.2487/854 - D4.203, 4.212, 4.236, 4.248
- P.2487/845 - 6.354, 6.354-4, T6.354-4
- 2. P.2487/004 - Tous moteurs
- 3. P.31419 - Tous moteurs sauf 4.318 et 6 cyl.
- 4. P.3178/6412 - 3.152, D3.152, 4.203, D4.203
- P.3178/7437 - 4.212, 4.236, 4.248
- P.3178/5007 - 4.236, 4.248
- P.3178/7424 - 4.318

**Non original replacements**

**VILEBREQUINS ET PIÈCES CONNEXES**

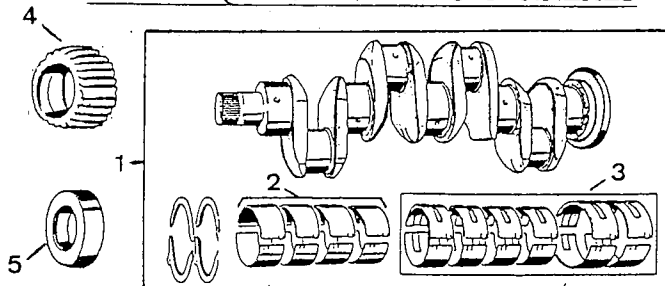

**1. VILEBREQUINS COMPLETS**

- P.84402 - 3.152, D3.152 (A)
- P.94458 (U5BG0027) - D3.152 (B)
- P.84417 (U5BG0030) - 4.107, 4.108
- P.85811 (U5BG0028) - 4/203, 4.203, D4.203 (A)
- P.94455 - D4.203 (B)
- P.85719 - 4.212 (A)
- P.94430 - 4.212 (B)
- P.84422 (U5BG0054) - 4.236 (A), 4.248 (A)
- P.94435 (U5BG0024) - 4.236 (B), 4.248 (B)
- P.94434 (U5BG0025) - 4.248 (MF.290,590,3060)
- P.68607 - 4.318 (B)
- P.50045 (U5BG0045) - 6.354 (A)
- P.50048 (U5BG0048) - 6.354 (B)
- P.68076 (U5BG0037) - 6.354-4

(A) Type avec bourrage palier arrière tressé  
(B) Type avec bague d'étanchéité au palier arrière.

**2. JEUX DE COUSSINETS DE BIELLE (COTES STANDARD):**

- P.85036 - A.152, D3.152, T3.152
- P.85037 - 4.107, 4.108
- P.85035 - 4/203, 4.203, D4.203
- P.85042 - 4.212, 4.236, 4.248
- P.85041 - 4.318
- P.85043 - 6.354, 6.354-4

**3. JEUX DE COUSSINETS DE PALIERS (COTES STANDARD)**

- P.58703 (68084) - 3.152, D3.152, T3.152
- P.84492 - 4.107, 4.108
- P.59617 (68082) - 4/203, 4.203, D4.203
- P.81558 - 4.212, 4.236, A.248
- P.83392 (68085) - 4.318
- P.85010 - 6.354
- P.68079 - 6.354-4

**4. PIGNON DU VILEBREQUIN**

- P.0410132 - 3 cyl., A.152, D.152
- P.0410228 - 4 cyl., 4.192, 4.203, D4.203
- P.3117/1681 - 4 cyl., 4.212, 4.236, T4.236, T4.248
- P.3117/1211 - 6 cyl., 6.354-4

**5. BAGUE D'ETANCHEITE AVANT:**

- P.0730098 - 4.107, 4.108
- O.2414111 - (Cuir) | 3.152, D3.152, 4/203
- O.2415344 - (Viton) | 4.203, D4.203
- P.34157 - 3/144, 4.192
- P.2415/361 - (Silicon) | 4.212, 4.236, T4.236,
- P.2418/436 - (Viton) | 4.248, T4.248, 6.354, T6.354, 6.354-1, 6.354-4, T6.354-4



**PALIER ARRIERE DU VILEBREQUIN**

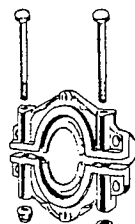

- P.4142/2034 - 3/144, 3.152, 4.192
- P.3688/3106 - Bourrage tressé

- P.86749 - 4/203, 4.203, D4.203 (ZZ.90029)

- P.3688/3106 - Bourrage tressé

- P.59537 - 4.212, 4.236, T4.236 (ZZ.90044)

- P.3688/3108 - Bourrage tressé



- P.3688/3107 - Bourrage (4.107, 4.108)



- O.2415391 - Bague silicon | Tous mot.
- P.2418/475 - Bague viton | équipés.

**BIELLES ET PIÈCES CONNEXES**

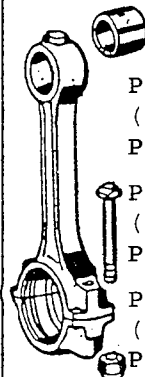

- P.59908 - Bielle complète (ZZ.90011) 3/144, 3.152, 4.192, 4.203
- P.3113/4151 - Bague supérieure

- P.91051 - Bielle complète (ZZ.90010) D3.152, D4.203
- P.3113/4123 - Bague supérieure

- P.84920 - Bielle complète (ZZ.90009) 4.212, 4.236, 4.248, 6.354-4
- P.3113/4123 - Bague supérieure

- P.0095250 - Boulon | Pour bielles
- P.3322/1319 (33221327) Ecrou | P.59908, P.91051

- P.3276/2116 (32762144) Boulon | Pour bielle
- P.3322/1321 (33221328) Ecrou | P.84920

**VOLANT DU MOTEUR**

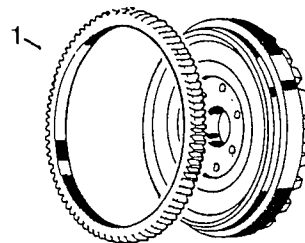

- P.0921062 (Tous moteurs)
- M.828123 Roulement (Tracteurs M-F)

- 1. P.0410236 - 3/144, 3.152, D3.152, 4.192, 4.203, D4.203, 4.212, 4.236, T4.236, 4.248, T4.248, 6.354
- P.0410264 - 4.318, 6.354-1, 6.354-4, T6.354

**PASTILLES ANTI-GEL**



- P.0650567 - Ø 25,8
- P.0650563 - Ø 32,2 (0650710)
- P.0650618 - Ø 35,4
- P.0650577 - Ø 38,4 (32418122)

**Non original replacements**

**POMPES A HUILE COMPLETES**

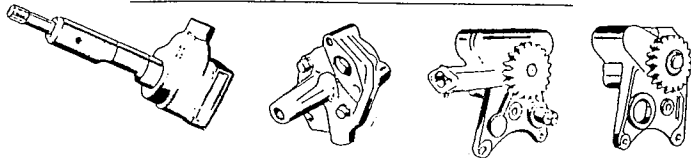

- P.4131/4089 (41314092) - 4.107,4.108
- P.4131/4078 - 3.152,D3.152
- P.4131/4087B (41314164) - 4.203,D4.203
- P.4131/4054 - 4.212,4.236,4.248

(Moteurs sans équilibreur)

- P.4132/F.021 - Avec équilibreur 4111K051, montage central

- P.4131/4113 - 4.318
- P.4131/4131 - 6.354

(Axe de 216 mm.)

- P.4131/4067 - 6.354,6.354-1, T6.354-1

(Axe de 280 mm.)

- P.4132/F.015 - 6.354-4
- P.4132/F.016 - T6.354-2/3 et 4

**EQUILIBREUR**

P.4173/3066 (41733082)

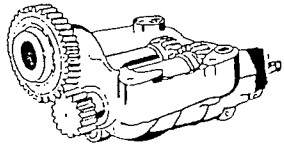

Montage avant (1ère série)

P.4111/K051

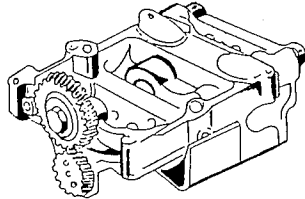

Montage central (2ème série)

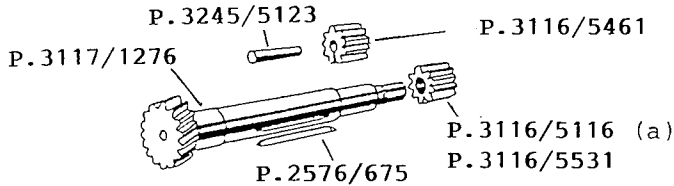

MF.B.1244 - Kit comprenant:  
P.3117/1276 + P.3245/5123 + P.3116/5531  
P.2576/675 + P.3116/5461

(a) P.3116/5116, pignon pour arbre ancien, n° 31171272 (pas compris dans le kit MF.B.1244)

A) MF.A.89/12 - Paire de roulements (2558375 + 2558371)

A) MF.A.89/34 - Paire de roulements (255718 + 2557176)

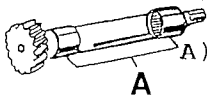

**PIPES DE CIRCULATION D'EAU**



- 1. P.3774/7581 - 3/144,3.152, D3.152

- P.3774/6643 - 4.212,4.236 (37735651)

- 2. 30/37766362 - 3/144,3.152, (37766361) D3.152

- P.3774/8211 - 4.212,4.236 (37762701-3-4)

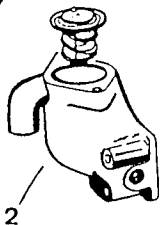

**CULASSES COMPLETES**

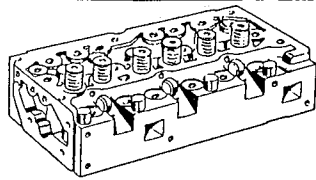

- P.86553 - (68131,ZZ.80058) - 3.152
- P.86550 - (68128,ZZ.80082) - D3.152
- P.86521 - (ZZ.80033) - D4.203
- P.86584 - (68115,ZZ.80054) - 4.212,4.236, 4.248
- P.68116 - (ZZ.80062) - 4.248 (MF.290, 590,690)
- P.80023ZZ - (ZZ.80023) - 4.318

**SOUPAPES, GUIDES, RESSORTS**

- 1. P.3326/1723 - 3.152,D3.152
- 2. P.0780006 - 4.203,D4.203
- 3. P.0780007 -

- 4. P.3143/1261 - ADM. | 3.152,4.192,4.203
- 5. P.0910002 - ECH. |

- 4. P.3143/1281 - ADM. | D3.152 (angle 45°)
- 5. P.3143/1271 - ECH. | D4.203 (31431591)

- 4. P.3143/1681A - ADM. | D3.152
- 5. P.3143/1011 - ECH. | (angle 35°)

- 4. P.3143/1641 - ADM. | 4.212,4.236,4.248
- 5. P.3143/1881 - ECH. | Tige côte std. (\*)

- 4. P.3143/1315 - ADM. | 4.248 (côte std.)(\*)
- 5. P.3143/1881 - ECH. | MF.565,575,590

- 4. P.3143/1154 - ADM. | 4.318
- 5. P.3143/1671 - ECH. |

- 6. P.3381/7125 - 4.212,4.236,4.248,6.354

(\*) Côtes réparation sur demande.



**COLLECTEURS D'ECHAPPEMENT**

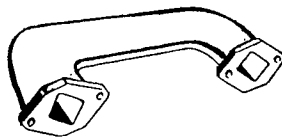

- 30/37781251 - 3/144,3.152
- 30/37781341 - D3.152 (37781571)
- 30/37781781 - 4.212,4.236 (377881321-332-333)

**THERMOSTATS**

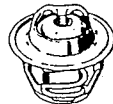

- P.2485/644 - (Ø 69,5 mm.) - 4.203,D4.203, (2485668) T6.354
- P.2485/645 - (Ø 54 mm., 82°) - 3/144,3.152, (2485666) D3.152,4.107,4.108, 4.318,6.354
- P.2485/659 - (Ø 54 mm., 82°) - 4.212,4.236, 4.248
- P.2485/653 -
- P.2485/613 - 6.354-4,T6.354-4

**ENTRAINEURS DE TACHYMETRE**

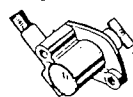

- P.2758/348 - 4.212,4.236,4.248
- P.2758/314 - 6.354,T6.354 et dérivés

**Non original replacements**

**POMPES A EAU ET JEUX DE REPARATION**

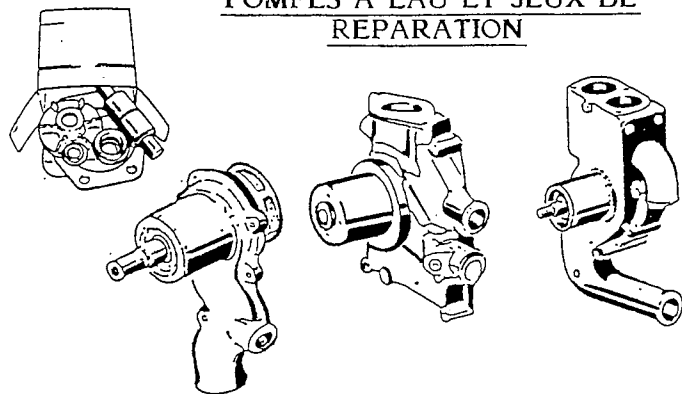

**NOTE:** Applications sur Massey-Ferguson (agriculture et industrie), Landini et Renault, voir pages à ces marques.

- P.50026 - Pompe - P3/TA
- P.58293 - Jeu réparation - 3/144
- P.50023 - Pompe (A) - 3.152,D3.152
- P.58293 - Jeu réparation
- P.50054 - Pompe (A) - 4.107,4.108
- P.4131/2510 - Pompe (A) - 4.203,D4.203
- P.59140 - Jeu réparation
- P.4131/2914 - Pompe (A) - 4.212,4.236,4.248
- P.85800 - Jeu réparation (86151)
- P.86957 - Jeu réparation (U7LW0025)
- P.89034 - Jeu réparation (U7LW0026)
- P.4131/2557 - Pompe (A) - 6.354,T6.354
- P.59101 - Jeu réparation
- P.4131/2809 - Pompe (A) - 6.354-4 (certains)
- P.89007 - Jeu réparation
- P.4131/3027 - Pompe (A,B) - 6.354-4 (certains)  
T6.354-4
- P.68575 - Jeu réparation
- P.4131/3029 - Pompe (A,D) - 6.354-4,T6.354-4
- 30/68578 - Jeu réparation

- (A) Sans poulie
- (B) Long. sortante de l'axe: 70 mm.
- (D) Long. sortante de l'axe: 82 mm.

**REFERENCES INTERCHANGEABLES:**

4131 2055 = P.4131/2494	U5MW010 = P.4131/2510
4131 2245 = P.4131/2914	U5MW014 = P.4131/2419
4131 2424 = P.4131/2557	U5MW023 = P.50023
4131 2784 = P.4131/2494	U5MW041 = P.50054
4131 3018 = P.4131/2557	U5MW055 = P.4131/2510
4131 3033 = P.4131/2809	U7LW0002 = P.70029
4131 3045 = P.4131/2557	U7LW0006 = P.85800
4131 3047 = P.4131/2809	U7LW0009 = P.59101
4131 3225 = P.4131/2914	U7LW0015 = P.68575

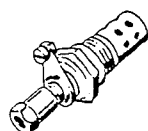

**BOUGIE DE PRECHAUFFAGE**

M.1854050 - Tous moteurs PERKINS  
(2666103,2666108)

**POMPES D'ALIMENTATION**

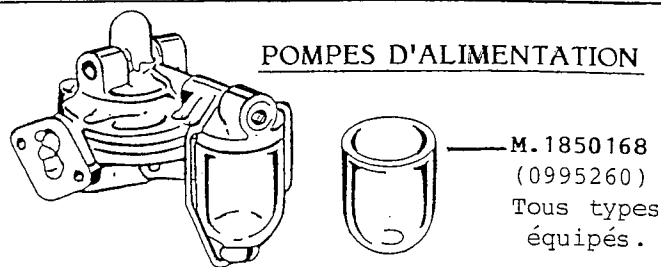

M.1850168  
(0995260)  
Tous types équipés.

**NOTE:** Applications sur Massey-Ferguson (agriculture et industrie), Landini et Renault, voir pages à ces marques.

- P.2641/305 - 4.107,4.108
- P.2641/40F (A) - 3.152,D3.152 (Pompe avec bol  
(2641406/8) décanteur)
- P.2641/311 (B) - D3.152 (Pompe sans bol  
(2641712) décanteur)
- P.2641/345 (C) - 4.203,D4.203 (Pompe avec bol  
(2641A065) décanteur)
- P.2641/328 (D) - 4.203,D4.203 (Pompe sans bol  
(2641327) décanteur)
- P.2641/465 (E) - 4.212,4.236,4.248 (Fixation  
(2641478) 2 trous)
- P.2641/709 (F) - 4.212,4.236,4.248 (Fixation  
(2641725) 4 trous, sorties en ligne)
- P.2641/711 (G) - 4.212,4.236,4.248 (Fixation  
(2641728) 4 trous)
- P.2641/333 - 4.318  
(2641336)
- P.2641/372 (I) - 6.354,6.354-1,6.354-2,T6.354,  
(2641A064) T6.354-1 (Fixation 2 trous)
- P.2641/715 - 6.354,6.354-2,T6.354-2,  
T6.354-3
- P.2641/719 (H) - 6.354-4,T6.354-4 (Fixation  
(2641720) 4 trous)

**JEUX DE REPARATION POUR POMPES "AC"**

- P.2641/0042 - Pour pompes "AC" A,B
- P.2641/0045 - Pour pompes "AC" C,D,I
- P.2641/0050 - Pour pompes "AC" E

**COMMANDE AUXILIAIRE (6.354,6.354-4,T6.354-4)**

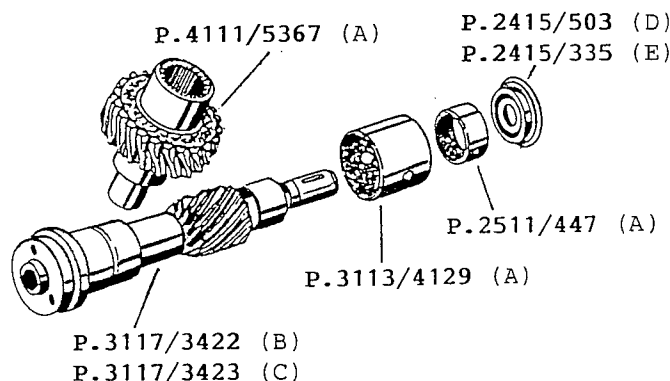

- (A) Tous -moteurs
- (B) 6.354,6.354-2,T6.354
- (C) 6.354-4,T6.354-4
- (D) Avec axe 31173406 ou 31173409 (1er montage)
- (E) Avec axe 31173422 ou 31173423

**FILTRES A HUILE ET A COMBUSTIBLE**

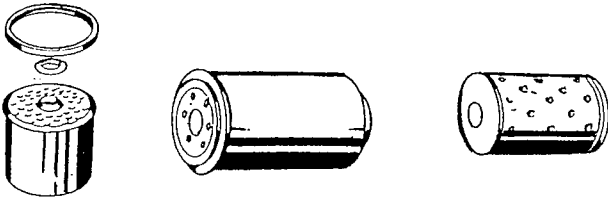

**NOTE:** Applications sur Massey-Ferguson (agriculture et industrie), Landini et Renault, voir pages à ces marques.

**ELEMENTS PAPIER (FILTRE HUILE):**

- 103 - (26540132) - 3.152, D3.152, 4.107, 4.108, 4.192
- 102T - (26560090) - 4.203, D4.203, 4.212, 4.236, 4.248, P.3/TA, 3/144, 4.270
- 143 - (26540153) - 4.270, 4.236, 6.354

**FILTRES VISSES (HUILE):**

- 465 - (2654408) - D3.152
- 599AR - (2654403) - D4.203, 4.212, 4.236, 4.248
- 267 - (2654407) - 6.354, 6.354-1, 6.354-4, T6.354-4

**FILTRES A COMBUSTIBLE:**

- 1005 - (C.A.V. 7111/44) - 3.152, 4.107
- 1087/PK - (26561117) - Tous moteurs avec filtre C.A.V. 7111/296, 296
- 1193 - (26560602) - Moteurs 4 et 6 cyl. avec filtre C.A.V. 7111/796, 796
- 1157 - (Bosch 1457.434.055) | Certains montages
- 1194 - (Bosch 1457.434.058) | allemands

**REFERENCES INTERCHANGEABLES:**

TRA N°	CROSLAND	AC-DELCO	MANN
102T	403	AC.34A	
103	487	AC.20	
143	481	AC.72	
267	616		
465	307	X.51	
599AR	532,637	PF.1,X.38	W.940-1
1005	455	ACD.50	
1087/PK	522	ACD.51	
1157	658		WK.731
1193	620	ACD.519	
1194	303	XD.67	WK.842

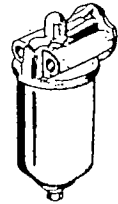

**FILTRE A HUILE COMPLET**

P.2654/026 - Avec élément papier 3.152, 4.107

**TETES DE FILTRE VISSE**

- P.3776/4251 - 3.152, D3.152, 4.203 D4.203
- P.3776/4181 - 4.212, 4.236, 4.248

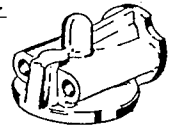

**DECANTEURS EN VERRE**



- 7111-403 - Fond plat (9001-103)
- 7111-429 - Fond bombé (9001-112)



Pour les autres pièces détachées de filtres "C.A.V." et "ROTO-DIESEL" voir fascicule 1.

**JOINTS ET POCHETTES DE JOINTS POUR MOTEURS**

**NOTE:** Applications sur Massey-Ferguson (agriculture et industrie), Landini et Renault, voir pages à ces marques.

Moteurs	A Culasse	B C/Soupapes	C Rodage	D Complémentaire
4/99, 4.107			P.59596	P.59597 1/2
3/144	P.0490580	P.0490491	P.960546	P.5902K
3.152	P.3681/2122	P.0490491	P.83398	P.85000
3.152D	P.3681/2127	P.3681/1115	P.82886	P.82887 (1er type) P.94422 (2ème type)
4.192	-	-	P.83372	P.83373
4.203	-	-	P.83393	P.83373
4.203D	P.3681/2126	P.3681/1112	P.82907	P.82908 (1er type) P.83451 (2ème type)
4.212,				
4.236,	P.3681/2341	P.3681/1114	P.82890	P.92440
4.248,				
4A.318	P.3681/2324	P.0490770	P.69027	P.68211
6A.354-4	P.3681/2613	P.3681/1443	30/P.50033	30/P.50022B
T6.354-4	P.3681/2613	P.3681/1443	30/P.50034	30/P.50002
T6.354-1	P.3681/2547	P.3681/1443	30/P.50026P	30/P.50024P

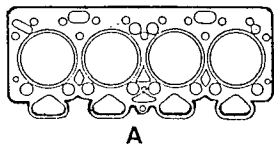

A



B

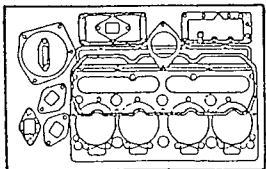

C = Pochette rodage

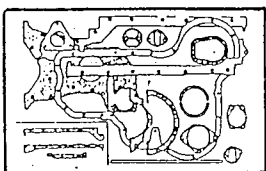

D = Pochette complémentaire

**REFERENCES INTERCHANGEABLES**

68016	= P.83373	36812138	= P.3681/2126
68036	= P.83451	36812349	= P.3681/2341
69035	= P.83372	U5LB.0011	= P.94422
83381	= P.59596	U5LB.0012	= P.85000
92453	= P.59597 1/2	U5LB.0016	= P.92440
3681E006	= P.3681/2127	U5LT.0012	= P.83398
36812132	= P.3681/1114	U5LT.0013	= P.82886
36812136	= P.3681/2122	U5LT.0015	= P.82890
		U5LT.0038	= P.82886

**Non original replacements**

REFERENCES INTERCHANGEABLES

32116	= P.2414/324	0070172	= M.1851751	2415344	= P.2415/343
32274	= P.2415/209	81210	= P.90039ZZ	2415346	= P.2415/345
32327	= 1001	81252	= P.90039ZZ	2418F436	= P.2418/436
32531	= P.2641/0043	82885	= P.92440	2418F475	= P.2418/475
32550	= P.2485/645	82891	= P.85800	24850017	= M.826772
32589	= P.2641/345	83381	= P.59596	2485628	= P.2485/645
32957	= P.2641/0054	83400	= P.85000	2485639	= P.2485/644
33841	= P.2485/645	83427	= P.83451	2485648	= P.2485/645
33873	= P.2485/644	83437	= P.59617	2485657	= P.2485/644
35273	= P.2641/406	83451	= P.92440	2485659	= P.2485/644
36202	= M.826772	84774	= P.91051	2485666	= P.2485/645
40152	= P.84402	84956	= P.82906	2485668	= P.2485/644
40185	= P.86550	85007	= P.92440	2485685	= P.2485/644
40210	= P.86553	85009	= P.85800	2487854	= P.2487/841
40225	= P.84957	85780	= P.82890	2612B418	= P.2612/418
49018	= P.58293	85781	= P.92440	2614B145	= P.2612/419
53851	= P.960546	85795	= P.92440	2614B152	= P.2614/152
54361	= P.4142/2027	85847	= P.83451	26410015	= P.2641/0042
55319	= P.83372	86151	= P.86957	26410030	= P.2641/0073
58012	= P.83398	86780	= P.86778	26410039	= P.2641/0007
59626	= P.82907	86979	= P.92440	26410049	= P.2641/0050
68006	= P.92440	89019	= P.58293	2641A063	= P.2641/311
68011	= P.92440	89024	= P.59140	26410089	= P.2641/0045
68013	= P.92440	89214	= P.89209	26410089	= P.2641/491
68011	= P.83451	89298	= P.82890	26410090	= P.2641/0045
68016	= P.83373	89297	= P.89263	2641314	= P.2641/305
68032	= P.92440	89298	= P.82890	2641336	= P.2641/333
68036	= P.83451	89625	= P.82890	2641346	= P.2641/345
68082	= P.59617	92421	= 30/P.50024P	2641406	= P.2641/40F
68083	= P.58703	92427	= P.82890	2641461	= P.2641/465
68109	= P.86584	92432	= P.83451	2641462	= P.2641/465
68115	= P.86584	92453	= P.59597 1/2	2641478	= P.2641/465
68128	= P.86550	92485	= P.85811	2641720	= P.2641/719
68131	= P.86553	94490	= 30/P.50024P	2641725	= P.2641/709
68184	= P.86521	94494	= 30/P.50024P	2641728	= P.2641/711
68211	= P.68611	94429	= P.82890	26510236	= M.880271
68248	= P.89263	94485	= P.83451	26540218	= 111
68267	= P.83398	284181	= M.1808525	26560017	= 1087/PK
68286	= 30/P.50025	0420002	= P.3326/1723	26560602	= 1193
68288	= 30/P.50025	0730071	= P.3688/3108	26561117	= 1087/PK
68301	= P.82878	0730080	= P.3688/3106	2666103	= M.1854050
68306	= P.81565	0730090	= P.34157	2758346	= P.2758/348
68332	= P.82111	0910001	= P.3143/1261	2758347	= P.2758/348
68501	= P.84957	0920113	= M.826218	31171272	= P.3117/1276
69003	= 30/P.50026P	0950200	= P.4131/2511	31171275	= P.3117/1276
69005	= 30/P.50026P	2188161	= M.353917	31312424	= P.84402
69006	= 30/P.50026P	2414325	= P.2414/324	31312427	= P.84402
69048	= P.69027	2415207	= P.2415/209	31312429	= P.84402
0070106	= M.890982	2415216	= P.2415/209	31312432	= P.84402
0070108	= M.960972	2415325	= P.2415/324	31315135	= P.85811

**Non original replacements**

**REFERENCES INTERCHANGEABLES**

31315142 = P.85811	41312055 = P.4131/2494	U5.BG0028 = P.85811
31315144 = P.85811	41312063 = P.4131/2511	U5.BG0031 = P.84402
31315145 = P.85811	41312066 = P.50054	U5.LB0005 = P.92440
31315431 = P.3117/1276	41312147 = P.50054	U5.LB0011 = P.94422
31358345 = P.3135/8322	41312154 = P.4131/2494	U5.LB0012 = P.85000
31358352 = P.3135/8347	41312159 = P.4131/2487	U5.LB0016 = P.92440
31358441 = P.3135/8341	41312167 = P.4131/2511	U5.LT0012 = P.83398
31358533 = P.3135/8521	41312245 = P.4131/2915	U5.LT0015 = P.82890
31431591 = P.3143/1271	41312254 = P.50054	U5.LT0015 = P.89263
31431104 = P.3143/1881	41312323 = P.4131/2915B	U5.LT0024 = 30/P.50024P
33817117 = P.3381/7125	41312354B = P.4131/2915B	U5.LT0025 = 30/P.50025
3681A008 = PO.490770	41312366 = P.4131/2915B	U5.LT0026 = 30/P.50026P
3681E006 = P.3681/2127	41312416 = P.4131/2487	U5.LT0038 = P.82886
36811122 = P.3681/1114	41312459 = P.50054	U5.LW0006 = P.89034
36811132 = P.3681/1114	41312551 = P.4131/2915B	U5.MH0001 = P.3482/1422
36812315 = P.3681/2341	41312574 = P.4131/2511	U5.MH0026 = P.3482/8462
36812327 = P.3681/2324	41312774 = P.4131/2938	U5.MK0036 = P.4308K
36812334 = P.3681/2341	41312784 = P.4131/2494	U5.MW0010 = P.4131/2510
36812335 = P.3681/2324	41313018 = P.4131/2557	U5.MW0014 = P.4131/2419
36812338 = P.3641/2341	41313201 = P.4131/2915B	U5.MW0016 = P.4131/2609
36812347 = P.3681/2324	41313212 = P.4131/2914	U5.MW0023 = P.50023
36812348 = P.3681/2324	41313225 = P.4131/2914	U5.MW0041 = P.50054
36812544 = P.3681/2535	41313808 = P.4131/2609	U5.MW0054 = P.50054
36812547 = P.3681/2535	41314164 = P.4131/4087B	U5.MW0055 = P.4131/2510
36812548 = P.3681/2535	41733082 = P.4173/3066	U7.LW0006 = P.85800
36822135 = M.897938	41733402 = P.4173/3066	U7.LW0009 = P.59101
36821112 = M.827877	CAV.357/2 = M.1854104	U7.LW0015 = P.68575
36822135 = M.897938	CAV.357/5 = M.1854050	U7.LW0016 = 30/68578
41158026 = P.83388	M7.BJ0014 = P.91051	ZZ.80023 = 30/68186
41158044 = P.86753	M7.BJ0015 = P.84920	ZZ.80025 = P.86550
41158045 = P.86775	M7.BJ0052 = P.59908	ZZ.80033 = P.86521
41158057 = P.84957	PF.52729 = M.1641148	ZZ.80054 = P.68120
41158058 = P.82906	PF.53636 = P.2414/111	ZZ.80054 = P.86584
41158063 = P.84955	PF.55397 = M.960029	ZZ.80058 = P.86553
41158065 = P.86781	U5.BG0024 = P.94435	ZZ.80062 = P.68116
41158118 = P.86754	U5.BG0027 = P.94458	

**DEMARREURS, ALTERNATEURS, GENERATRICES POUR MOTEURS "PERKINS"**

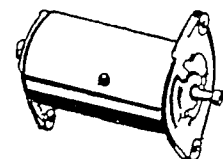
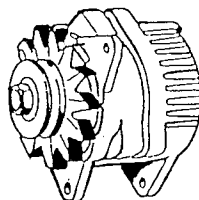
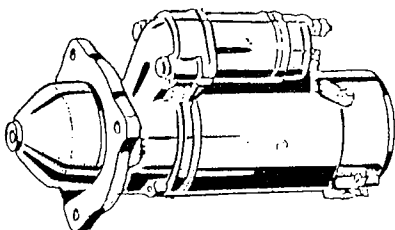

Pour tracteurs agricoles: voir aux pages "LANDINI", "MASSEY-FERGUSON", "RENAULT DMA".  
 Pour autres engins: communiquer la référence du démarreur, de l'alternateur ou de la génératrice à remplacer et du moteur concerné.  
 (Exemple: démarreur Lucas 26264 pour moteur D4.203)

**Non original replacements**