



AGRIA-PASQUALI- LANDINI-EBRO-KUBOTA
AUSA-BARREIROS-BJR-DAVID BROWN-
LA VERDA-MOTRANSA-SAME-VALPADANA

EMBRAGUES
AGRICOLAS E INDUSTRIALES

INTRODUCCIÓN

Les presentamos el CATÁLOGO actualizado con los modelos de:

- ↪ DISCOS DE EMBRAGUE.
- ↪ CONJUNTOS DE PRESIÓN.
- ↪ COJINETES DE EMPUJE.
- ↪ KITS (Disco, Conjunto, Cojinete)

EXPLICACIONES DE IDENTIFICACIÓN

Casilla "TIPO"

- ↪ EP En preparación.
- ↪ F Disco **flexible** con forros orgánicos.
- ↪ R Disco **rígido** con forros orgánicos.
- ↪ R / C Disco **rígido** con placas cerámicas.
- ↪ M Conjuntos convencionales de **muelles**.
- ↪ D Conjunto de **diafragma**.
- ↪ 60 - Desde el año 1960
- ↪ 60 Hasta el año 1960
- ↪ 60 / 70 Desde el año 1960 al 1970

INTRODUCTION





We proudly present you the latest updated catalogue with the following models:





- ↪ CLUTCHING DISKS.
- ↪ CLUTCHES.
- ↪ PUSHING BEARINGS.
- ↪ KITS (Disks, Clutches, Bearings)





IDENTIFICATION EXPLANATION





"TIPE" box





- ↪ EP In preparation.
- ↪ F **Floppy** disk with organic lining.
- ↪ R **Rigid** disk with organic lining.
- ↪ R / C **Rigid** disk with pottery plates.
- ↪ M Ordinary **spring** clutches.
- ↪ D **Diaphragm** clutches.
- ↪ 60 - Since 1960
- ↪ 60 Until 1960
- ↪ 60 / 70 Since 1960 to 1970





AGRICOLA MARCA Y MODELO		 DISCO					 CONJ. PRESIÓN		 COJINETE	 KIT
MOTOR	AÑO	REFERENCIA	Ø EXTERIOR	Nº ESTRIAS	Ø ESTRIADO	TIPO	REFERENCIA	TIPO	REFERENCIA	REFERENCIA
AGRIA										
MOTOCULTOR 7700		4-15	110	8	15	R	A-1	D	CE-184	K-1407
MOTOCULTOR		6-17/1	160	13	22	R				
MOTOCULTOR 1700 D		6-17/3	160	12	20,3	R	A-2	M		
MOTOCULTOR 1900 (-carter 4364243) MOTOCULTOR 2900 (-carter 4364187) TRACTOR 8900 D (-carter 917948)		7-17/2	180	14	25	R	AH-1	M	CE-15	
MOTOCULTOR 1900 (carter 4364244-) MOTOCULTOR 2900 (carter 4364188-) TRACTOR 8900 D (carter 917949-)		7-17/2	180	14	25	R	SS-19/A	D	CE-79	
MOTOCULTOR 2700	(69-)	7-17/2	180	14	25	R	AH-1/C	M		
MOTOAZADA 7000		6-17/4	160	9	17	R	A-4	M		
TRACTOR 8800, 8845		10-23	254	14	25	R	AH-2	M	CE-15	
TRACTOR 9945		10-23	254	14	25	R	AH-3	M	CE-15	
TRACTOR 9900, 8800, 8838		10-23	254	14	25	R	AH-2	M	CE-15	
1700 HATZ Motor E-75		6-17/3	160	12	20,3	R				
2800 HATZ Motor NR 4106123 2800 HATZ Motor NR 4104 756 2800 HATZ Motor NR 4106234		7-17/2	180	14	25	R				
1900 HATZ 1900 D HATZ 2800 HATZ 3800 Lombardini 4800 HATZ 2700 Ruggerini Motor RD 901 3800 Ruggerini Motor CRD 100 p 4800 Ruggerini Motor CRD 100 p 4900 Ruggerini Motor RD 92/2 5700 Ruggerini Motor CDR 100 p 6700 Ruggerini Motor RD 90/2 6900 Ruggerini Motor RD 92/2		7-17/2	180	14	25	R	AH-1	M	CE-15	
DUMPER 1500		6-05/5	180	10	7/8"	R	RA-305	M	CE-61	
ALFA (AGRICOLA)										
MOTOCULTOR A-700 14 CV. MOTOCULTOR A-716 16 CV. TRACTOR Motor Lombardini 14 CV. TRACTOR Motor Lombardini 16 CV.		6-17	160	20	17	R				
ARO CARPATI										
243D, 244D		10-15 10-14	250	10	1 3/8"	R F				





MARCA Y MODELO		 DISCO					 CONJ. PRESIÓN		 COJINETE	 KIT
MOTOR	AÑO	REFERENCIA	Ø EXTERIOR	Nº ESTRIAS	Ø ESTRIADO	TIPO	REFERENCIA	TIPO	REFERENCIA	REFERENCIA
AUSA										
DUMPER Super D - 302/11		6-07/2	160	10	7/8"	R	A-2	M		
DUMPER Normal D - 302 1501 - DS Senior 1501 - DSH Senior Giratorio 121 - DE Junior CE - 1001 Carretilla 1501 - DA Senior		6-07/2	160	10	7/8"	R	A-3	M		
150 DH LKS		6-07/2	160	10	7/8"	R	A-2	M		
150 DH LKA		6-07/2	160	10	7/8"	R	A-3	M		
150 DH DITER, ISUZU, HARTZ 175 RMS, HARTZ CE-10, ISUZU		6-05/5	180	10	7/8"	R	A-32	D		
2200 MS Master 2200 MT Master		6-05/5	180	10	7/8"	R	D-4	M		
2200 MS CE-10 DITER		6-05/5	180	10	7/8"	R	D-4	M		
LK Super, LK SR		6-05/5	180	10	7/8"	R	A-32	D		
2200 MS con pala CE-15 DITER		8-54	215	10	7/8"	F	S-13	M		
2200 MS Motor CE-16 ISUZU		8-54	215	10	7/8"	F	S-13	M		
CARRETILLA 2000 CS 2000 CT		8-54	215	10	7/8"	F	S-13	M		
C-11 ISUZU		8-54	215	10	7/8"	F	S-124	D		
DUMPER 993		8-54	215	10	7/8"	F	S-24	D		
CE-16 ISUZU 3 LB-1		10-36	240	10	7/8"	F	A-34	D		
DUMPER 2 cil. 34 CV. CARRETILLA 2 cil. 34 CV.		10-16	250	10	7/8"	F	A-6	M		
30 MT, 300 RM, 350 AM DITER 200 RM LOMBARDINI		10-16	254	10	7/8"	F	A-6	M		
200 RM, 250 RM, 300 RM 3 LB1, 3 LD1		10-16	254	10	7/8"	F	A-6/C	M		
200 RM, 250 RM LOMBARDINI		10-16	254	10	7/8"	F	A-6/B	M		
CE-16 3 LB-1		10-16	254	10	7/8"	F	A-6	M		
CS-20, CS-25, DITER CE-20 CV-20 ISUZU, CS-20 LOMBARDINI CS-25 LOMBARDINI		10-16	254	10	7/8"	F	A-6	M		
CV-20, C-22 ISUZU		10-16	254	10	7/8"	F	A-6/C	M		
DUMPER y CARRETILLA 2 CL		10-16	254	10	7/8"	F	A-6	M		
CV-25		11-50	276	10	7/8"	F	EB-1	M		
BARREIROS										
R - 335 S R - 350 S R - 500 B		11-39	276	10	32	R	B-2	M	CE-12	





MARCA Y MODELO		 DISCO					 CONJ. PRESIÓN		 COJINETE	 KIT
MOTOR	AÑO	REFERENCIA	Ø EXTERIOR	Nº ESTRIAS	Ø ESTRIADO	TIPO	REFERENCIA	TIPO	REFERENCIA	REFERENCIA
BARREIROS										
R - 440 2ª Serie		11-39	276	10	32	R	B-2	M	CE-12	
MOTOR 3 cilindros 36/42 CV. R - 355 R - 350 4000 4000 V 4045		11-39 11-39 PLCE	276	10	32	R	B-2	M	CE-51	
R - 440 1ª Serie		9-145	254	10	32	R			CE-48	
MOTOR 3 cilindros 42 CV. (EMBRAGUE DOBLE) 4045		10-03/3 10-18 10-19	276 225 225	15 23 23	26 38,8 38,8	R F R				
MOTOR 3 CILINDROS 42 CV. (EMBRAGUE DOBLE) 5055		10-03/3 10-18 10-19	276 225 225	15 23 23	26 38,8 38,8	R F R				
MOTOR 4 cilindros 52 CV. R - 440 R - 500 5000 V		11-39	276	10	32	R	B-2	M	CE-51	
MOTOR 4 cilindros 52 CV. 5000 5055		11-39 11-39 PLCE	276	10	32	R	B-3	M		
MOTOR 4 cilindros 70 CV. (EMBRAGUE DOBLE) 5500 7000		11-21/B 10-03/4	280 280	10 10	1 1/8" 1 3/4"	R R			CE-52	
MOTOR 4 cilindros 70 CV. (EMBRAGUE DOBLE) 7070		12-67 PLCE 9-200	310 225	10 27	1 1/8" 45	R F				
MOTOR 4 cilindros 70 CV. (EMBRAGUE DOBLE) 7070		11-21/B 10-03/4	280 280	10 10	1 1/8" 1 3/4"	R R				
MOTOR B - 24 77 CV. R - 545 A R - 545 I	(-8/73) (-8/73)	13-81	350	10	40	R				
MOTOR B - 24 77 CV. R - 545 A R - 545 I	(-8/73) (-8/73)	13-81 PLCE	350	10	40	R/C				
MOTOR B - 24 77 CV. R - 545 A R - 545 I	(8/73-) (8/73-)	13-81/7	350	10	40	R				
MOTOR B - 24 77 CV. R - 545 A R - 545 I	(8/73-) (8/73-)	13-81/7 PLCE	350	10	40	R/C				
7070 - Tracción	(2/75-)	12-59 12-59 PLCE	310 310	10 10	1 1/8" 1 1/8"	R R/C				
CARRETILLA CB - 2500 CB - 3500		11-37	278	10	1 1/2"	R				
CARRETILLA CB - 2500 CB - 3500		11-37 PLCE	278	10	1 1/2"	R/C				





MARCA Y MODELO		 DISCO					 CONJ. PRESIÓN		 COJINETE	 KIT
MOTOR	AÑO	REFERENCIA	Ø EXTERIOR	Nº ESTRIAS	Ø ESTRIADO	TIPO	REFERENCIA	TIPO	REFERENCIA	REFERENCIA
BENFORD										
3 Ton.	(75-82)	10-27/4	250	10	1 3/8"	R				
DUMPERS BD,BC15,SB,SM23	(70-)	8-213	200	10	1 "	R				
TS40,MA2000	(74-)	9-187 9-188	232 232	10 10	1" 1"	R F	SV-1	M	CE-12	
TT3000(4WD)	(82-)	10-72	250	10	1"	F	JD-4	M	CE-12	
BIELARUS										
TRACTOR		11-37	280	10	1 1/2"	R				
B. J. R.										
F - 672		9-144/1	254	10	1 1/4"	F	SV-2	M		
VE - T 1.400 ME - T 1.800 ME - 707 VE - 637		6-05/8	180	10	7/8"	R	D-4	M		
CARRARO ANTONIO										
CARRARINO (Monodisco)		4-15	110	8	15	R	A-1	D	CE-184	K-1407
CLAAS										
COSECHADORA MW/M AKD - 9 SUPER JUNIOR con VW 122 MERCUR - EUROPA - COLUMBUS COMET - COSMOS - CORSAIR REF. ORIGINAL 507.906		7-15/D	180	10	29	R				
COMEVASA										
MOTOCULTOR con Motor Diter DB - 90		6-06/3	160	10	15/16"	R	R-1	M	CE-2	
COMOPLESA										
MAQUINARIA OBRAS PUBLICAS Con Motor Diter		6-07/2	160	10	7/8"	R	R-1	M	CE-2	
DAVID BROWN										
990, 995 Modelo Live Drive		10-03/4	280	10	1 3/4"	R				
DEUTZ										
FAHR M - 66		7-117	200	10	29	R				
FAHR M-88, M-99		7-119	225	10	29	R				
D - 50 EMBRAGUE DOBLE D - 50 S D - 50.1S AVANCE D - 55 D - 5505		11-21/2	280	10	1 1/8"	R				





MARCA Y MODELO		 DISCO					 CONJ. PRESIÓN		 COJINETE	 KIT
MOTOR	AÑO	REFERENCIA	Ø EXTERIOR	Nº ESTRIAS	Ø ESTRIADO	TIPO	REFERENCIA	TIPO	REFERENCIA	REFERENCIA
DEUTZ										
AGROCOMPACT/C 3.70 F/V 3.90 F/S		11-80 PLCE 11-83	280 280	20 17	40 32	F/C R				
3.70 F/V 3.50 F/S/V		11-84 10-71	280 250	20 17	40 32	F R				
AGROPRIMA 4.31,4.51,4.56,6.06,6.16		12-68 PLCE 11-85 12-69 12-71	310 280 310 310	21 16 16 21	45 35 35 45	F/C R R R				
AGROSTAR 4.61,4.71,(8 PLACAS)		12-73 PLCE	310	21	45	R/C				
AGROXTRA D 1006 U		11-93 PLCE 12-75 13-95 PLCE	295 310 327	23 16 23	48 30 48	R/C R R/C				
D25,D30		8-211 8-215	200 200	10 10	32 26	R R				
D25,D25/1,D25/1S		8-217	200	10	32	R				
D25/2,D30		8-219	200	10	26	R				
D2807F		9-189	225	20	40	R				
D3006F,D3607F		9-191	225	10	26	R				
D3006		9-193	225	10	40	R				
D3607		10-79	250	10	32	R				
D3607		9-185	225	17	32	R				
D40L,D40/2		9-197 9-199	225 225	10 10	40 32	R R				
D40UF(MOT.F3L712,40/1S)		9-201 10-73	225 250	8 10	42 29	R R				
D4505		11-78 11-81	280 280	8 10	42 32	F R				
D4505		11-85	280	10	32	R				
D4507F Desde 7548/7815		11-87 9-203	280 228	20 17	40 32	R R				
D50,50S,50/1S		10-75 11-21/2	250 280	8 10	42 29	R R				
D6006F		11-89 10-77	295 250	8 10	42 32	R R				
D6806U,D6807A,C,CA		12-77 11-91	310 280	8 10	42 32	R R				
DK75B,BF,DL75		14-05	350	8	42	R				
DK90,100B,DR120		15-01 PLCE	380	8	42	R/C				



MARCA Y MODELO		 DISCO					 CONJ. PRESIÓN		 COJINETE	 KIT
MOTOR	AÑO	REFERENCIA	Ø EXTERIOR	Nº ESTRIAS	Ø ESTRIADO	TIPO	REFERENCIA	TIPO	REFERENCIA	REFERENCIA
DITER(MOTORES)										
DA - 70		6-06	155	6	17	F	S-12	M		
LKA - LKA - E - LKB LCAR - LCD		6-17/9	160	10	23	R	R-1	M		
LKS		6-05/5	180	10	7/8"	R				
MWM D - 325, 2 Y 3		11-48	280	10	1 3/8"	F				
MWM D - 325, 4 Y 6		13-10	327	10	1 1/2"	F				
TARCO		6-07/2	160	10	7/8"	R	R-1	M		
DUMPERSA										
DUMPER DH 2500 Kgs.		8-54	216	10	7/8"	F	S-13	M		
APISONADORA AV - 6 (Motor Deutz)		9-31	225	10	1 3/8"	R	LR-1	M		
EBRO KUBOTA										
MOTOR EBRO 38/60 CV. EBRO 44 EBRO 48 SUPER EBRO EBRO 155 EBRO 160(Espesor entreforros 12 mm.)		11-41/1	280	10	1 3/8"	R	EB-1	M		
MOTOR EBRO 38/60 CV. EBRO 44 EBRO 48 EBRO 155 EBRO 160 SUPER EBRO (Espesor entreforros 10 mm.)		11-49	280	10	1 3/8"	R	EB-1	M		
MOTOR PERKINS 6305 78 CV. EBRO 183		12-53 12-53 PLCE	325 325	10 10	1 3/8" 1 3/8"	R R/C	EB-2	M	CE-42	
MOTOR PERKINS 4236 72 CV. EBRO 470		11-49	280	10	1 3/8"	R	EB-1	M	CE-35	
MOTOR PERKINS 4236 82 CV. EBRO 480 (Espesor entreforros 12 mm.)		11-41/1	280	10	1 3/8"	R	EB-1	M	CE-35	
MOTOR PERKINS 4236 82 CV. EBRO 480(Espesor entreforros 10 mm.)		11-49	280	10	1 3/8"	R	EB-1	M	CE-35	
MOTOR PERKINS 6.305 78 CV. EBRO 684		12-53 12-53 PLCE	325 325	10 10	1 3/8" 1 3/8"	R R/C	EB-2	M	CE-42	
EBRO 6090 Turbo Motor P4236T EBRO 6100 EBRO 6125 Turbo Motor P6354 con conjunto de muelles)		13-91 PLCE	350	16	43,50	R/C				
KUBOTA 6090 KUBOTA 6125 Con conjunto de diafragma		13-91/1 PLCE	350	16	43,50	R/C				
EBRO 6067,6070,6077,6079		12-11/3 10-27/9	302 250	10 25	1 1/8" 1 5/8"	R R				
EBRO 6070,7079 Estándar		12-11/3	302	10	1 1/8"	R				





MARCA Y MODELO		 DISCO					 CONJ. PRESIÓN		 COJINETE	 KIT
MOTOR	AÑO	REFERENCIA	Ø EXTERIOR	Nº ESTRIAS	Ø ESTRIADO	TIPO	REFERENCIA	TIPO	REFERENCIA	REFERENCIA
EBRO KUBOTA										
C - 50 (EMBRAGUE DOBLE) E - 350 E - 460	(tracción) (Toma fuerza)	11-51/2 11-51/1	280 280	33 10	37 45	R R	SR-1	M		
MOTOCULTORES MOTOSEGADORAS A - 21 - A - 30 - 3 - AL 100 ART 82 - 1 AZ - 2 AZ - 8 CZ		6-05/5	180	10	7/8"	R	P-5	M		
MOTOCULTORES 35 AL 15 AZ		7-17/9	215	10	7/8"	R				
100 ART 82 29 AL 9 AZ 10 AZ		6-05/5	180	10	7/8"	R	P-5	M		
EBRO (JEEP AGRÍCOLA)										
JEEP BRAVO, COMANDO Motor 4108 Perkins		9-62	235	10	15/16"	F	JV-2	M		
JEEP COMANDO Motor Barreiros C-60		9-62	235	10	15/16"	F	JV-2	M		
JEEP CAMPEADOR Motor P4192, P4203		9-64	232	10	15/16"	F	JV-1	M		
FAHR										
1DA,2DA,2DN,D12N,15,17N,22P D160H,180H,181		7-117	200	10	29	R				
FENWICH										
J-107 Z		11-25 11-25 PLCE	276 276	10 10	35 35	R R/C	EB-1	M		
JUNIOR D 3 P MAJOR SENIOR SECO		12-15 12-15 PLCE	302 302	10 10	1 1/2" 1 1/2"	R R/C				
JUNIOR (original 3006386)		10-29 10-29 PLCE	250 250	10 10	30 30	R R/C				
JUNIOR D 3 P MAJOR SENIOR HUMEDO		11-45 11-45 PLCE	280 280	10 10	1 1/2" 1 1/2"	R R/C	F-6	M		
FERRARI										
TRACTOR F - 95		7-36/1	181	20	23	F				
MOTOCOLTIVATORI 71 (1" Serie)		4-15	110	8	15	R				
FIAT										
MODENA 400 x 6, 400/6		10-14	254	10	1 3/8"	F				
616 ORLETTA 40135 616		9-144	254	10	32	F				





MARCA Y MODELO		 DISCO					 CONJ. PRESIÓN		 COJINETE	 KIT	
MOTOR	AÑO	REFERENCIA	Ø EXTERIOR	Nº ESTRIAS	Ø ESTRIADO	TIPO	REFERENCIA	TIPO	REFERENCIA	REFERENCIA	
FIAT											
ORLETTA 40135		9-145	254	10	32	R					
643 EP		13-64/3	350	10	2"	F					
684 N, T		13-64/5	380	10	1 3/4"	F					
GUTHELFER											
TRACTOR LKA		6-07/2	160	10	7/8"	R	R-1	M			
HOLDA											
TRACTOR A - 12		7-16/B	180	10	1 1/8"	F					
HOLMAN IBÉRICA											
COMPRESOR		11-48 11-49	280 280	10 10	1 3/8" 1 3/8"	F R	B-4	M			
HUMSA (HUESCA DE MAQUINARIA)											
DUMPER 1200		6-17/9	160	10	23	R	R-1	M			
IMER											
MOTOZAPPA Serie 115		4-15	110	8	15	R	A-1	D	CE-184	K-1407	
JCB - BAMFORD J.C.											
JCB 2, 3, 3C, 3CS, 4CS JCB EXCAVADORA BMC MK 11, FORD 956E		12-53 PLCE	325	10	1 3/8"	R/C	EB-2	M			
FASTRAC 1115,1135,1125,130T 145T,150T		14-14 PLCE	350	10	1 3/8"	F					
JOHN DEERE											
443 (1020)		10-03/7	250	15	26	R	JD-4	M			
MOTOR PERKINS 3.144 45 CV. 505 515 515 C		10-14	254	10	1 3/8"	F	JD-7 (sin anillo) JD-4 (con anillo)	M M			
MOTOR PERKINS 3.144 45 CV. 505 515 515 C		10-15/A	254	10	1 3/8"	R	JD-7 (sin anillo) JD-4 (con anillo)	M M			
MOTOR PERKINS 4.203 57 CV. 717 818		11-48 11-49	276 280	10 10	1 3/8" 1 3/8"	F R	JD-5	M			
EMBRAGUE DOBLE (tracción) 71 (Toma fuerza) 818		11-03/2 10-03/1	280 280	8 10	50 29	R R					
MOTOR JD - 3 cilindros 47/57 CV. 820,830,840,920,940 1020 1030 LU 1030 VU		10-03/7	250	15	26	R	JD-4	M	RO-50		





MARCA Y MODELO		 DISCO					 CONJ. PRESIÓN		 COJINETE	 KIT
MOTOR	AÑO	REFERENCIA	Ø EXTERIOR	Nº ESTRIAS	Ø ESTRIADO	TIPO	REFERENCIA	TIPO	REFERENCIA	REFERENCIA
JOHN DEERE										
A1806		7-03	180	10	29	R				
T100,200		7-117	200	10	29	R				
T300,500,700		10-08	250	10	32	F				
T310,510		10-09 10-06	250 250	8 10	50 29	R F				
T710		11-03/2 11-95	280 280	8 10	50 29	R R				
MOTOR JD - 3 cilindros 57 CV. EMBRAGUE DOBLE										
1020 (Tracción)		10-03/3	276	15	26	R			RO-50	
1030										
1035 (Toma fuerza)		10-18	225	23	39	F				
1630 (Toma fuerza)		10-19	225	23	39	R				
1635										
1020		11-92	280	15	26	F				
1120		10-03/3	280	15	26	R				
1130										
MOTOR JD-3 cilindros 47/57 CV										
1030							JD6	M	RO-50	
1035		10-03/3	276	15	26	R				
1520										
1620										
1635										
EMBRAGUE DOBLE (Tracción)										
1030 LU		10-03/3	276	15	26	R			RO-50	
1030 VU (Toma fuerza)		10-18	225	23	39	F				
		10-19	225	23	39	R				
1215		6-17/9	160	10	23	R				
1315										
1350		11-92	280	15	26	F				
1530		11-92 10-03/3	280 280	15 15	26 26	F R				
1550		9-205 10-03/3 11-92	225 280 280	10 15 15	26 26 26	R R F				
1630										
1830		11-92	280	15	26	F				
1640		10-03/3	280	15	26	R				
1840										
1750,1850/N,1950/N		11-92	280	15	26	F				
MOTOR JD3 cilindros 2.9										
1040V,1640FN,1840FA		11-92	280	15	26	F				
MOTOR JD4 cilindros 3.9										
2040FA		11-92 PLCE 8-212	280 193	15 23	26 38	F/C F				
MOTOR JD 3 cilindros 2.9 52 CV. EMBRAGUE DOBLE										
1140 A (Tracción)		11-92 11.92 PLCE	280 280	15 15	26 26	F F/C			RO-50	
1140 F (Toma fuerza)		10-18	225	23	39	F				
1140 M		10-19	225	23	39	R				
1640,1840,2040,2240 (4cil.)		13-26 13-40 PLCE	320 320	15 15	26 26	F F/C				





MARCA Y MODELO		 DISCO					 CONJ. PRESIÓN		 COJINETE	 KIT
MOTOR	AÑO	REFERENCIA	Ø EXTERIOR	Nº ESTRIAS	Ø ESTRIADO	TIPO	REFERENCIA	TIPO	REFERENCIA	REFERENCIA
JOHN DEERE										
2040S		13-46 PLCE	327	10	1 1/4"	F/C				
2040S		13-48 PLCE	320	10	1 1/4"	F/C				
2130		9-145/2 12-50	302 302	10 10	1 1/4" 1 1/4"	R F				
2140		13-46 PLCE	327	10	1 1/4"	F/C				
2250 2450		10-18 10-03/3 11-92	225 280 280	23 15 15	38 26 26	F R F				
2650		13-46 PLCE	327	10	1 1/4"	F/C				
2850		13-50 PLCE	327	10	1 1/4"	F/C				
3050 3350 3640		13-46 PLCE	327	10	1 1/4"	F/C				
MOTOR JD 4 cilindros 3.9 2040,2140 Turbo MOTOR JD 5 cilindros 5.8 3340 Turbo 3340ª Turbo		13-44 13-44 PLCE 9-180	320 320 235	10 10 27	1 1/4" 1 1/4" 45	F F/C F				
2040,2140,3040,3140,3640		13-42	330	10	1 1/4"	F				
MOTOR JD - 4 cilindros 72 CV 2020 2030 2035 2120		10-03/3	276	15	26	R	JD-6	M	RO-50	
EMBRAGUE DOBLE 2020 2030 2035 2120	(Tracción) (Toma fuerza)	10-03/3 10-18 10-19	276 225 225	15 23 23	26 39 39	R F R			RO-50	
MOTOR JD - 4 cilindros 77 CV. 2130 2135		11-03/5 9-192	302 235	15 23	26 38	R F			RO-50	
2130 2135		11-03/5 PLCE	302	15	26	R/C			RO-50	
MOTOR JD - 4 cilindros 77 CV. EMBRAGUE DOBLE 2130 2135	(Tracción) (Toma fuerza)	11-03/5 9-192	302 235	15 23	26 38	R F				
MOTOR JD - 6 cilindros 90 CV. 3120 3130 3135		9-145/2 9-145/2 PLCE	302 302	10 10	1 1/4" 1 1/4"	R R/C			RO-50	
EMBRAGUE DOBLE 3120 3130 3135	(Tracción) (Toma fuerza)	9-145/2 9-180	302 235	10 27	1 1/4" 45	R F				
JOHN DEERE-COSECHADORAS										
1055,1065,1068,1072		12-79	310	10	1 3/8"	R				





MARCA Y MODELO		 DISCO					 CONJ. PRESIÓN		 COJINETE	 KIT
MOTOR	AÑO	REFERENCIA	Ø EXTERIOR	Nº ESTRIAS	Ø ESTRIADO	TIPO	REFERENCIA	TIPO	REFERENCIA	REFERENCIA
JOHN DEERE-COSECHADORAS										
1075,1085,1177,1188		13-97 PLCE	327	10	1 3/8"	R/C				
1166,1169,1174		12-79	310	10	1 3/8"	R				
330,430,930,940		10-11	250	10	1 1/4"	R				
4425		12-79	310	10	1 3/8"	R				
530,630,730,950,960,970,		10-69 10-69 PLCE	250 250	10 10	1 3/8" 1 3/8"	R R/C				
925,935,940,955,965H,968,975 1055,1065,1068,1075,1085		12-29 PLCE 12-29	305 305	10 10	1 3/8" 1 3/8"	R/C R				
Harvester		11-94 11-96	280 280	10 10	1 1/4" 1 1/4"	F F				
Mahdrescher		8-221	215	10	1 1/4"	R				
LAURAK										
CARRETILLA C - 30 Salev - Groca M - 55		11-26 11-25/D 11-25 PLCE	280 280 280	10 10 10	35 35 35	F R R/C	B-3	M		
CARRETILLA ELEVADORA BR-15		8-49/1 8-49/1 PLCE	216 216	10 10	23 23	R R/C	S-13	M		
CARRETILLA ELEVADORA		9-27	230	10	29	R				
13 A 9016 9019 PL - 3		9-27/1	200	10	29	R				
LAVERDA										
M - 84 MIETITREBIA (Ref. original 100.7850)		8-55	215	10	35	R				
M - 100 M - 120 - 15		10-27/2	250	10	35	R				
M - 120 11 - S M - 150 (Ref. original 1848250)		11-35	275	10	35	R				
COSECHADORA con motor FIAT M - 152 - OM		12-03/4	302	10	35	R				
LEVANTE										
PALA CARGADORA (sobre tractor EBRO)		12-53/3	327	10	1 3/8"	R				
LISKA DIESEL										
COSECHADORA 1600		8-69	200	10	1 3/8"	R	E-4	M		





MARCA Y MODELO		 DISCO					 CONJ. PRESIÓN		 COJINETE	 KIT
MOTOR	AÑO	REFERENCIA	Ø EXTERIOR	Nº ESTRIAS	Ø ESTRIADO	TIPO	REFERENCIA	TIPO	REFERENCIA	REFERENCIA
LOMBARDINI										
C - 1 - C - 7 - 226 S - 230 S		7-17/7	180	10	7/8"	R				
C - 230		7-17/9	215	10	7/8"	R				
MASSEY-FERGUSON										
1004T		13-98	327	21	29	F				
1004,1004T 298,592,595,698T,698GB		13-99 13-101 PLCE	327 327	10 10	1 1/8" 1 1/8"	R R/C				
1014		13-103 PLCE 12-101	330 310	23 16	48 30	R/C R				
1014 1114 1134		13-103 PLCE 13-105	330 327	23 16	48 30	R/C R				
1080		12-105	302	10	1 1/8"	R				
1200		13-107 PLCE	327	21	29	R/C				
133,133MK3 135,140,148 152,152P3 155,158,165 165 France 165 G.B 168 France 168 G.B. 185 France 185 G.B. 188 France 188 G.B 20 D/H 235,240,245,250 255,260,265,275 285,290,342,550 565,575,590,675 690		12-11/3 10-27/9	302 250	10 25	1 1/8" 1 5/8"	R R				
35,50,65,65S 133,135,140,145,165, 168,175,177,178,203 205		11-47 9-29	273 225	10 10	1 1/8" 1 3/4"	R R				
133,135 140 France 148 France 148 G.B 152,155,157,165, 168 France,G.B. 175,177,178 185 France,G.B 188 France,G.B 500		12-11/3 10-27/5	302 250	10 10	1 1/8" 1 3/4"	R R				
133,135,140 148 France 148 G.B 152,155,165 MK3 165 G.B 168 G.B 230,240,250,255,550		12-11/3 12-11/3 PLCE	302 302	10 10	1 1/8" 1 1/8"	R R/C				
134 154 S/V174 S/V		11-98 11-97	280 280	14 10	40 25	F R				





MARCA Y MODELO		 DISCO					 CONJ. PRESIÓN		 COJINETE	 KIT
MOTOR	AÑO	REFERENCIA	Ø EXTERIOR	Nº ESTRIAS	Ø ESTRIADO	TIPO	REFERENCIA	TIPO	REFERENCIA	REFERENCIA
MASSEY-FERGUSSON										
135		11-99 9-29	278 225	10 10	1 1/8" 1 3/4"	R R				
154-4 154S 164		11-98 11-100 PLCE 11-97	280 280 280	14 14 10	40 40 25	F F/C R				
184S 194 A,F,S 283,284,293,294 276 CF,377,383 LX,S 384 AQ,F,S 393 LX,S-394 F 396 CF		11-100 PLCE 11-97	280 280	14 10	40 25	F/C R				
TED (TVO) TEA 20 TEC 20		9-31	225	10	1 3/8"	R				
233S,CF 234S,CF 253,254,263,264CF,T 273,274		11-98 11-100 PLCE 11-97	280 280 280	14 14 10	40 40 25	F F/C R				
174S,V 244CF 333,334V 353,354F,V,354S 363,364F,V,CFS 374FS,V		11-98 11-97	280 280	14 10	40 25	F R				
2620,2625,2640,2645 2680,2685,2720,2725 3610,3630,3635,3645 3650,3655,3670		14-73 PLCE	350	23	2"	R/C				
3050,3055,3060,3065 3070,3075,3080,3085 3090,3095,3115,3120 3125		13-109 PLCE 13-109	327 327	23 23	2" 2"	R/C R				
342,350,355,360,375,390,		12-107	302	21	29	R				
350,352,355,360,365 375,390		12-100 10-27/9	302 250	21 25	29 1 5/8"	F R				
350,352,355,360,365,375,		12-100	302	21	29	F				
342,350,355,360,365 375,390,		12-107 10-27/9	302 250	21 25	29 1 5/8"	R R				
390T,398,		13-98 13-100 PLCE	327 327	21 21	29 29	F F/C				
685S		9-207	225	10	32	R				
698,699		13-98	327	21	29	F				
MASSEY FERGUSSON HARVESTER-COSECHADORAS										
16,20,25 330,430		9-209	225	10	29	R				
186,187,206,240,307 440,487,506,507		9-211	225	10	35	R				





MARCA Y MODELO		 DISCO					 CONJ. PRESIÓN		 COJINETE	 KIT
MOTOR	AÑO	REFERENCIA	Ø EXTERIOR	Nº ESTRIAS	Ø ESTRIADO	TIPO	REFERENCIA	TIPO	REFERENCIA	REFERENCIA
MASSEY FERGUSSON HARVESTER-COSECHADORAS										
31		7-131	180	10	29	R				
86,87		9-207	225	10	32	R				
MAQUINARIA INDUSTRIAL										
MAQUINARIA TEXTIL		11-25	280	10	35	R	B-4	M		
MOTRANSA										
MOTOR BMLC 3.4 60 CV. 551, 1060		11-49/D	280	10	1 3/8"	R				
MOTOR BMLC 3.8 64 CV. 652 751 2461 4461		11-49/D	280	10	1 3/8"	R	SN-1	M		
EMBRAGUE DOBLE MOTOR 3.8 652 2461 4461	(Tracción)	10-03/3	276	15	26	R				
	(Toma fuerza)	10-18 10-19	225 225	23 23	39 39	F R				
MOTOR PERKINS 6.305 79 CV. 751 851 2467 2472 2679 4467 4679 TIGER SUPER TIGER		12-53/1 12-53/1 PLCE	327 327	10 10	1 1/2" 1 1/2"	R R/C				
O. M.										
LEONCIO ECO 2 D Eng. 34114 - 2 DAINO 45 CO 2 D eng. 36104 - 2 CO 3 eng. 38104 - 2 CO 3 eng. LUPPETTO MCO - 2D eng. 30, 33, 29, 102, 2, CO - 3 eng. 24164, 2 CO - 3 eng. TIGROTTO Diesel 55 CO 3 D eng.		11-48	276	10	1 3/8"	F	SV-6	M		
CHEVIATO 40 CWT TRUCK LUPETTO ECO 1K eng. 25 CO - 2 D eng. ECO LD, eng. 25 CO 1 K eng. 39 CO 1 K eng.		10-14/1	254	10	1 3/8"	F				
ONDO										
TRACTOR ALKAR		6-05	160	6	22	R	AL-1	M	CE-1	

MARCA Y MODELO		 DISCO					 CONJ. PRESIÓN		 COJINETE	 KIT
MOTOR	AÑO	REFERENCIA	Ø EXTERIOR	Nº ESTRIAS	Ø ESTRIADO	TIPO	REFERENCIA	TIPO	REFERENCIA	REFERENCIA
OVAC										
MOTOCULTOR con motor Lombardini		7-15/1	160	10	7/8"	R	R-2	M		
PASQUALI										
MOTOCULTOR 12 H.P. "MR"		6-09/1	160	10	29	R	P-1	M		
MOTOCULTOR 906 (el moyu del disco en forma campana)		7-15/B	180	10	29	R	P-3	M		
MOTOCULTOR 14 Y 18 CV. 906 945 946		7-15/A	180	10	29	R	P-3	M	CE-78	
MOTOCULTOR 14 CV.		6-23	160	10	7/8"	R	P-1	M		
MOTOCULTOR 956 21 CV. MOTOCULTOR 957 20 CV. MOTOCULTOR 958 30 CV. MOTOCULTOR 990 21 CV. MOTOCULTOR 991 21 CV. MOTOCULTOR 995 25 CV. MOTOCULTOR 996 30 CV. MOTOCULTOR 997 - Motor Minsel MOTOCULTOR 980 E 28 CV. MOTOCULTOR 977 38 CV.		7-15/C	190	10	29	R	P-4	M	CE-78	
MOTOCULTOR 956 21 CV. MOTOCULTOR 957 20 CV. MOTOCULTOR 958 30 CV. MOTOCULTOR 990 21 CV. MOTOCULTOR 991 21 CV. MOTOCULTOR 995 25 CV. MOTOCULTOR 996 30 CV. MOTOCULTOR 997 - Motor Minsel MOTOCULTOR 980 E 28 CV. MOTOCULTOR 977 38 CV. Con Horquilla Lateral		7-15/C	190	10	29	R	P-11	M		
MOTOCULTOR con motor Diter MOTOCULTOR con motor Lombardini MOTOCULTOR con motor 40 CV. 983 38 CV.		8-15	215	10	29	R	S-16	M		
ERGO		9-53	225	17	32	R	P-16	D		
MOTOCULTOR P 462, 463, 496		8-15	215	10	29	R	P-15	M		
P. G. S.										
MOTOCULTOR		7-15/1	160	10	7/8"	R	AL-1	M		
MOTOCULTOR 32 CV. ROMA 35		7-15/P	184	10	7/8"	R	RA-7	M	CE-61	
TRACTOR 3 cilindros 37 CV. ROMA 55		7-17/9	215	10	7/8"	R	S-13	M	CE-61	
POCLAIN										
RETRO-EXCAVADORA TY - 45		10-27/2 10-27/2PLCE	250 250	10 10	35 35	R R/C	TY-45 TY-45 D	M D		
RETRO-EXCAVADORA TY - 75		11-25 11-25 PLCE	280 280	10 10	35 35	R R/C	TY-70	M		

MARCA Y MODELO		 DISCO					 CONJ. PRESIÓN		 COJINETE	 KIT
MOTOR	AÑO	REFERENCIA	Ø EXTERIOR	Nº ESTRIAS	Ø ESTRIADO	TIPO	REFERENCIA	TIPO	REFERENCIA	REFERENCIA
POCLAIN										
RETRO-EXCAVADORA TY - 80		12-57 12-57 PLCE	310 310	10 10	45 45	R R/C	TY-80	M	CE-86	
RAPID										
MOTOSEGADORA Con Motor Lombardini		5-11/A	130	18	20,8	R				
MOTOSEGADORA Con Motor Minsel RD-80		5-11	130	10	19	R				
UNIVERSAL		6-07/5	160	18	20,8	R				
RAYGAR										
MOTOAZADA PLUMA 17, 20, 21		6-07/2	160	10	7/8"	R	R-1	M		
MOTOAZADA PLUMA 23		6-07/3	160	10	19	R	R-1	M		
MOTOCULTOR Super Especial 14 CV.		6-07/3	160	10	19	R				
MOTOCULTOR (Motor Goldoni) 18 CV. MOTOCULTOR (Motor Goldoni) 20 CV. MOTOCULTOR (Motor Goldoni) 21 CV.		7-15/L	180	10	19	R	RA-5	M	CE-61	
TRACTOR Serie 900		7-15/L	180	10	19	R	RA-7	M	CE-61	
ROA										
MOTOCARRO		6-07/1	152	10	23	R				
ROMERO (TRACCION)										
CARRETILLA ELEVADORA CE - 252		11-49	280	10	1 3/8"	R				
PALA 552 PALA 752 PALA 764		12-53 12-53 PLCE	325 325	10 10	1 3/8" 1 3/8"	R R/C	EB-2	M		
SACA										
EMBRAGUE DOBLE TRACTOR S - 430 S - 432	(Tracción) (Toma fuerza)	11-20/4 11-21/4 9-29	280 280 225	10 10 10	1 1/8" 1 1/8" 1 3/4"	F R R				
TRACTOR S - 455		11-71	302	10	1 1/2"	R				
S.A.M.A (RENAULT)										
EMBRAGUE DOBLE SUPER 7 y R - 57	(Tracción) (Toma fuerza)	10-27/2 10-27/1	250 250	10 10	35 45	R R	SR-2	M		
R - 60		10-27/3	250	33	37	R				
EMBRAGUE DOBLE R - 86 R - 88	(Tracción) (Toma fuerza)	11-51/2 11-51/1	280 280	33 10	37 45	R R	SR-1	M		

MARCA Y MODELO		 DISCO					 CONJ. PRESIÓN		 COJINETE	 KIT
MOTOR	AÑO	REFERENCIA	Ø EXTERIOR	Nº ESTRIAS	Ø ESTRIADO	TIPO	REFERENCIA	TIPO	REFERENCIA	REFERENCIA
S.A.M.A (RENAULT)										
TRACTOR Motor 1181 TRACTOR Motor 1184 TRACTOR Motor 1981 TRACTOR Motor 1984	(Toma fuerza)	12-43	327	18	50	R				
SAME										
ASTER 60,70		11-101 PLCE 11-33 PLCE 11-103	280 280 250	20 20 14	40 40 1"	R/C R/C R				
ITALIA 30		8-03 7-133	212 187	10 20	29 40	R R				
ITALIA 35		9-03 8-05	225 200	10 22	29 45	R R				
DELFINO 32-35 SIRENETTA MINITAUR0		8-07 8-09	212 200	10 19	23 38	R R				
DA 250 PULEDRO		11-11 8-11	280 220	10 20	29 40	R R				
FALCON 50		10-25 9-213	250 230	14 20	25 40	R R				
MINITAUR0 FALCON MINITAUR0 60 CONDOR 55		11-13 10-27	280 250	14 20	25 40	R R				
CENTAUR0 CORSARIO 70 MINITAUR0 60		12-19 10-31	290 255	10 22	29 45	R R				
DA 250		11-29	280	10	35	R				
CORSARIO SINCHRO		12-25	290	10	35	R				
SATURNO 80 MERCURI 85, LEONE 70 CENTURION 75		12-78 11-31	320 262	10 22	29 45	F R				
LEOPARD		12-21	310	22	45	R				
LEOPARD JAGUAR 95		12-23 12-23 PLCE	325	24	50	R R/C				
DRAGO 100 BUFALO 120		13-38 13-03 13-03 PLCE 13-05	350 350 350 350	24 24 24 17	50 50 50 32	F R R/C R				
TIGER SIX 105 JAGUAR 95, 100, LEOPARD 90 TURBO LASER 90, 110, 130, 150, HERCULES 160 TITAN TRIDENT 130 GALAXY 170		13-09 PLCE 13-03 14-75 PLCE	350 350 350	24 24 24	50 50 50	R/C R R/C				
LEOPARD CRAWLER LEOPARD 85C		12-111 12-113	310 310	20 14	40 1"	R R				

MARCA Y MODELO		 DISCO					 CONJ. PRESIÓN		 COJINETE	 KIT
MOTOR	AÑO	REFERENCIA	Ø EXTERIOR	Nº ESTRIAS	Ø ESTRIADO	TIPO	REFERENCIA	TIPO	REFERENCIA	REFERENCIA
SAME										
LEOPARD, JAGUARD 95		12-23 12-98	325 330	24 24	50 50	R F				
SOLSUC										
Tractores y Maquinaria AGRICOLA		11-49	280	10	1 3/8"	R	B-3	M		
MOTOR PERKINS 4.108 TRACTOR 970		9-31	225	10	1 3/8"	R				
VALPADANA										
MOTOCULTOR 10 y 12 CV.		6-06/2	160	20	17,3	F	S-15	D		
TRATTORINO 4 RM 20 PADANO D - 12 SUPERPADANO D - 14 VCM 18		6-05/5	180	10	7/8"	R	RA-5	M	CE-61	
TRATTORINO 4 RM 350 TRATTORINO 4 RM 450		7-17/9	215	10	7/8"	R	S-13	M	CE-61	
ZETOR										
2011 2511 3011 3511 4712 4718		11-53 11-55 11-57 11-59 11-61 PLCE	280 280 280 280 280	28 28 16 16 16	45 45 25 25 25	R R R R R/C				
5011 6011 6045 6211 6245 7011 7045 7211 7245 7711 7745		12-115	310	18	28	R				
4011 4511 5511 5711 5718 5748 6711 6718 6748		11-53 11-55 11-69 11-73 11-75 11-77 11-77 PLCE	280 280 280 280 280 280 280	28 28 18 18 18 18 18	45 45 28 28 28 28 28	R R R R R R R/C				
NEW MODEL		12-27	302	28	45	R				
12011 12045		12-29/1 12-31 PLCE 12-33 PLCE	327 327 327	22 22 22	35 35 35	R R/C R/C				
CRISTAL 8011 8045		12-35 12-37 12-45 PLCE 12-47 PLCE	330 330 330 330	18 18 18 18	30 30 30 30	R R R/C R/C				

MARCA Y MODELO		 DISCO					 CONJ. PRESIÓN		 COJINETE	 KIT
MOTOR	AÑO	REFERENCIA	Ø EXTERIOR	Nº ESTRIAS	Ø ESTRIADO	TIPO	REFERENCIA	TIPO	REFERENCIA	REFERENCIA
ZETOR										
8111 8145 10111 10145		13-07 13-07 PLCE	350 350	22 22	35 35	R R/C				
12111 12145 16145 18145		14-07 14-07 PLCE	380 380	22 22	35 35	R R/C				

DESPIECE PARA REPARACIÓN CONJUNTOS DE PRESIÓN

APLICACIONES CONJUNTO	DENOMINACIÓN	REFERENCIA
PEGASO 170, 200, EUROPA	· Balancín completo	1151
	· Balancín	1152
	· Eje de Horquilla	1153
	· Eje de Balancín	1154
	· Cajera de Rodillos	1155
	· Horquilla	1156
	· Tuerca de Horquilla	1156 / A
.....		
PEGASO COMET	· Patilla	13-64 / 1106
	· Tornillo	13-64 / 1108
	· Tuerca	13-64 / 1109
	· Pasador	13-64 / 1110
.....		
MOTOR IBÉRICA	· Patilla completa	1002
	· Patilla	EB-1 / 1006
	· Tornillo	EB-1 / 1008
	· Tuerca	EB-1 / 1009
	· Pasador	EB-1 / 1110
	· Bisagra	EB-1 / 1115
.....		
MOTOR IBÉRICA (EBRO) EMBRAGUE 3 BALANCINES	· Balancín completo	1120

NOTA

PODEMOS SUMINISTRAR DESPIECE DE TODAS
LAS REFERENCIAS QUE EXISTEN EN ESTE CATÁLOGO

DISCOS DE FRENO TRACTORES

MARCA	REFERENCIA	Ø EXTERIOR	Nº ESTRIAS	Ø INTERIOR	TIPO
FENDIT	15.015	165	22	41/45 “	R
FORD	15.000	102	23	3/16 “	R
FORD	15.001	165	27	2 5/16 “	R
J.C.B.	15.002	165	13	45	R
J.C.B.	15.007	178	13	45	R
J.C.B.	15.008	178	23	2	R
MASSEY FERGUSSON	15.001	165	27	2 5/16 “	R
MASSEY FERGUSSON	15.002	165	13	45	R
MASSEY FERGUSSON	15.006	178	27	2 5/16 “	R
MASSEY FERGUSSON	15.010	223	27	2 5/16 “	R
RENAULT	15.003	152	37	1 5/8 “	R
RENAULT	15.004	165	37	1 5/8 “	R
SAME	15.000	102	23	1 3/16 “	R
SAME	15.007	178	13	45	R
URSUS	15.009	229	24	65	R
ZETOR	15.009	229	24	65	R



FORROS DE FRENO TRACTORES



MARCA Y MODELO	REFERENCIA	Ø EXTERIOR	Ø INTERIOR	ESPESOR
BARREIROS				
TRACTOR 7000, 550	FF - 101	178	101,6	5,2
TRACTOR R - 500	FF - 109	229	150	5
CLAAS				
3 / 36112 UTB	FF - 106	190	105	4,9
FIAT				
DENTADO EXTERIOR 28 DIENTES	FF - 110	239	181	5
JOHN DEERE				
DENTADO EXTERIOR 28 DIENTES	FF - 110	239	181	5
717, 818	FF - 104	152	80	5
MASSEY FERGUSSON				
DENTADO EXTERIOR 28 DIENTES	FF - 110	239	181	5
MOTOR IBÉRICA, S.A.				
155, 160, 684, SUPER 55	FF - 102	165	89	4,70
MF - 65 MASSEY FERGUSSON	FF - 105	179	101	4,70
MF - 175 MASSEY FERGUSSON	FF - 108	222	152	4,70
SAMA (RENAULT)				
R - 57, 86, 88 SUPER 7	FF - 107	152	80	5

RELACIÓN DE DISCOS MEDIDAS MODELOS

REFERENCIA	MEDIDAS	MODELOS	REFERENCIA	MEDIDAS	MODELOS
	Ø Nº Ø EXTERIOR ESTRIAS FONDO ESTRIA			Ø Nº Ø EXTERIOR ESTRIAS FONDO ESTRIA	
4 - 11	110 x 12 x 20		7 - 03	180 x 10 x 29	JOHN DEERE
4 - 15	110 x 8 x 15	AGRIA-CARRARO-IMER	7 - 04 *	190 x 24 x 20,4	AUDI
5 - 11	130 x 10 x 19	RAPID	7 - 05	180 x 24 x 20,5	
5 - 11/A	130 x 18 x 20,8	RAPID	7 - 06 *	190 x 24 x 20,4	AUDI
5 - 13	130 x 14 x 40,5		7 - 08 *	190 x 10 x 20	SKODA
6 - 03 *	160 x 6 x 30	TOCASA	7 - 10 *	190 x 18 x 20,2	SKODA
6 - 05	160 x 6 x 22	ONDO	7 - 12 *	180 x 18 x 20,6	NISSAN
6 - 05/4	160 x 20 x 22		7 - 14 *	180 x 32 x 52,4	ROVER
6 - 05/5	180 x 10 x 7/8"	AUSA-DITER	7 - 15/1	160 x 10 x 7/8"	OVAC-P.G.S.
6 - 05/8	180 x 10 x 7/8"	VALPADANA-KUBOTA	7 - 15/A	180 x 10 x 29	PASQUALI
6 - 05 /9	180 x 10 x 7/8"	B.J.R.	7 - 15/B	180 x 10 x 29	PASQUALI
6 - 06	155 x 6 x 17	SEAT - DITER	7 - 15/C	190 x 10 x 29	PASQUALI
6 - 06/1	155 x 20 x 17,3	SEAT	7 - 15/D	180 x 10 x 29	CLAAS
6 - 06/2	160 x 20 x 17,3	SEAT-EBRO-	7 - 15/L	180 x 10 x 19	RAYGAR
6 - 06/3	160 x 10 x 15/16"	VALPADANA	7 - 15/P	184 x 10 x 7/8"	P.G.S.
6 - 06/4	160 x 20 x 17,3	COMEVASA	7 - 16	180 x 24 x 20,5	MERCEDES (D.K.W.)
6 - 06/5	155 x 20 x 17,3	AUTOBIANCHI-SEAT	7 - 16/2	181,5 x 20 x 17	RENAULT
6 - 06/6	170 x 20 x 17,3	FIAT-SEAT EBRO	7 - 16/8	190 x 17 x 19	FIAT-SEAT-LANCIA
6 - 07/1	152 x 10 x 23	FIAT-SEAT-SEAT-	7 - 16/10	190 x 17 x 19	SEAT
6 - 07/2	160 x 10 x 7/8"	FIAT-ZASTAVA-	7 - 16/A	180 x 24 x 20,5	EBRO-MERCEDES-
6 - 07/3	160 x 10 x 19	LANCIA	7 - 16/B	180 x 10 x 1 1/8"	PERKINS
6 - 07/4	155 x 10 x 7/8"	ROA	7 - 16/E	180 x 21 x 17,6	HOLDA
6 - 07/5	160 x 18 x 20,8	AUSA-COMOPLESA-	7 - 16/F	180 x 21 x 17,6	TALBOT
6 - 09/1	160 x 10 x 29	DITER-RAYGAR-	7 - 16/L	180 x 18 x 20,9	TALBOT
6 - 11	160 x 10 x 17	GUTHELFER,BUCHER	7 - 16/H	180 x 21 x 17,6	PEUGEOT-TALBOT
6 - 15	160 x 24 x 20,5	RAYGAR	7 - 16/N	190 x 18 x 21	TALBOT
6 - 16	160 x 10 x 17	RAPID	7 - 16/2	180 x 14 x 25	PEUGEOT-TALBOT
6 - 16/1	160 x 21 x 17,6	PASQUALI	7 - 17/2	180 x 14 x 25	AGRIA
6 - 16/2	180 x 21 x 17,6	RENAULT	7 - 17/3	180 x 14 x 25	
6 - 16/3	160 x 20 x 17	TALBOT	7 - 17/4	180 x 10 x 7/8"	
6 - 16/4	170 x 20 x 17	TALBOT	7 - 17/5	180 x 24 x 20,5	
6 - 16/5	160 x 21 x 17,6	RENAULT	7 - 17/7	180 x 10 x 7/8"	LOMBARDINI
6 - 16/6	160 x 10 x 7/8"	ARO-DACIA-RENAULT	7 - 17/8	200 x 10 x 7/8"	
6 - 16/7	181,5 x 20 x 17	TALBOT	7 - 17/9	215 x 10 x 7/8"	EBRO KUBOTA-
6 - 16/8	160 x 10 x 7/8"	DACIA-PEUGEOT-FIAT	7 - 18	190 x 14 x 18,6	LOMBARDINI - P.G.S.
6 - 16/9	170 x 17 x 19	RENAULT-LANCIA	7 - 19 *	180 x 10 x 20	VALPADANA
6 - 17	160 x 20 x 17	SEAT	7 - 20	180 x 18 x 20,9	OPEL
6 - 17/1	160 x 13 x 22	ALFA	7 - 22	180 x 20 x 17,3	SKODA
6 - 17/3	160 x 12 x 20,3	AGRIA	7 - 25	180 x 10 x 1"	
6 - 17/4	160 x 9 x 17	AGRIA	7 - 26	190 x 24 x 20,4	AUDI-VOLKSWAGEN
6 - 17/9	160 x 10 x 23	AGRIA	7 - 27 *	180 x 24 x 20,4	VOLKSWAGEN
6 - 21	160 x 10 x 20,2	DITER-HUMSA	7 - 28 *	180 x 18 x 20,9	ROVER
6 - 23	100 x 10 x 7/8"	CITROEN	7 - 30 *	190 x 18 x 20,9	ROVER
6 - 27	160 x 10 x 20,2	PASQUALI	7 - 32 *	190 x 19 x 20	ROVER
6 - 27/7	160 x 18 x 20,2	CITROEN	7 - 34 *	180 x 24 x 20,4	VOLKSWAGEN
6 - 27/8	160 x 18 x 20,2	CITROEN	7 - 36	181,5 x 10 x 7/8"	SEAT
6 - 27/9	160 x 18 x 20,2	CITROEN	7 - 36/1	180 x 20 x 23	SEAT-FERRARI
6 - 27/10	180 x 21 x 17,7	CITROEN	7 - 36/2	180 x 20 x 17,3	SEAT
6 - 29	160 x 18 x 20,8	RAPID	7 - 36/3	180 x 26 x 21,9	RENAULT
6 - 32 *	170 x 14 x 18,7	OPEL	7 - 38	180 x 18 x 20,3	SUZUKI
			7 - 40	190 x 20 x 23	SUZUKI
			7 - 42	180 x 20 x 17,3	CITROEN-PEUGEOT
			7 - 44 *	181,5 x 18 x 20	TALBOT-RENAULT
			7 - 46	180 x 18 x 20,9	NISSAN
			7 - 48 *	180 x 24 x 20,4	CITROEN
					ALFA ROMEO

RELACIÓN DE DISCOS MEDIDAS MODELOS

REFERENCIA	MEDIDAS	MODELOS	REFERENCIA	MEDIDAS	MODELOS
	Ø EXTERIOR	Nº ESTRIAS	Ø FONDO	ESTRIA	
	Ø EXTERIOR	Nº ESTRIAS	Ø FONDO	ESTRIA	
7-50	190	24	20,4		ROVER-VOLKSWAGEN
7-52	181	24	20,4		
7-56	180	24	20,4		VOLKSWAGEN
7-58*	190	24	20,4		VOLKSWAGEN
7-60*	190	24	20,4		VOLKSWAGEN
7-62*	190	24	20,4		VOLKSWAGEN
7-64*	190	24	20,4		VOLKSWAGEN
7-66*	190	24	20,4		VOLKSWAGEN
7-68*	190	24	20,4		VOLKSWAGEN
7-70*	190	24	20,4		VOLKSWAGEN
7-72*	190	20	23		VOLVO
7-74*	181	18	20,8		CITROEN, PEUGEOT
7-76*	190	23	26		FORD
7-78*	181	17	19		LANCIA
7-80*	181	14	18,6		OPEL
7-82*	190	14	25		OPEL
7-84	180	18	25,3		
7-86	190	20	23		
7-94	200	10	29		MERCEDES
7-94/B	228	10	27		MERCEDES
7-94/C	228	20	23		SEAT
7-94/L	215	10	29		MERCEDES
7-98	200	6	25		SKODA
7-116	200	10	30		PEUGEOT
7-116/1	215	10	30		PEUGEOT
7-116/3	215	10	29		PEUGEOT
7-117	200	10	29		DEUTZ, JOHN DEERE
7-119	225	10	29		DEUTZ
7-129	180	32	53		AUSTIN-AUTHI- INNOCENT
7-131*	180	10	29		MASSEY FERGUSON
7-133*	187	20	40		SAME
.....					
8-02*	200	24	20,4		ALFA ROMEO
8-03*	212	10	29		SAME
8-04*	200	24	20,4		ALFA ROMEO
8-05*	200	22	45		SAME
8-06*	200	19	22		ALFA ROMEO
8-07*	212	10	23		SAME
8-08*	215	19	22		ALFA ROMEO
8-09*	200	19	38		SAME
8-10/1	200	10	7/8"		SEAT
8-11*	220	20	40		SAME
8-12*	215	20	23		ALFA ROMEO
8-14*	215	20	23		ALFA ROMEO
8-14/1	200	10	1 1/8"		AVIA
8-15	215	10	29		PASQUALI
8-16	200	14	25		OPEL
8-17*	200	24	20,4		VOLKSWAGEN
8-18*	210	23	24,3		AUDI
8-18/2	200	24	20,5		MERCEDES
8-18/3	200	24	20,5		EBRO
8-18/4	200	24	20,5		AVIA-EBRO
8-18/5	215	24	20,5		MERCEDES
8-18/6*	200	24	25,6		NISSAN
8-19	215	10	1"		
8-20	200	26	21,9		RENAULT
8-22*	210	23	24,3		AUDI
8-24*	200	24	20,7		OPEL
8-26*	200	24	20,4		AUDI
8-28*	210	23	24,3		AUDI
8-29	215	8	25		
8-30*	210	24	20,4		AUDI
8-32*	215	24	20,4		AUDI
8-34*	215	10	29		BMW
8-36*	215	10	29		BMW
8-38*	215	10	29		BMW
8-42*	215	23	26,2		DAF
8-44	215	10	15/16"		
8-46*	200	20	22		HONDA
8-48*	200	20	22		HONDA
8-49/1	216	10	23		LAURAK
8-49/1 PLCE	216	10	23		LAURAK
8-50*	200	20	22		HONDA
8-54	215	10	7/8"		SEAT-AUSA- DUMPERSA
8-54/1	200	20	23		
8-54/1 R	200	20	23		SEAT
8-54/2	200	23	26,2		TALBOT
8-54/9	200	20	23		FIAT-LADA-LANCIA- POLSKI-SEAT-SAVA
8-54/10	215	20	23		FIAT-SEAT-LANCIA
8-54/10 PLCE	215	20	23		
8-54/14	165	17	20,1		FORD
8-54/16	200	21	24,1		RENAULT
8-54/B	200	20	23		SEAT
8-55	215	10	35		LAVERDA
8-56	190	17	19,9		FORD
8-56/8	200	17	19		SEAT-FIAT-LANCIA
8-58	215	20	23		SEAT
8-60	200	17	19		SEAT
8-62	200	18	21		PEUGEOT-TALBOT
8-64	215	23	25,7		FORD
8-66	200	17	20,1		FORD
8-68	200	18	21		CITROEN-PEUGEOT
8-69	200	10	1 3/8"		LISKA DIESEL
8-70	215	24	25,6		NISSAN
8-71	215	24	65,5		
8-72	200	21	24,1		RENAULT
8-74	228	23	26		MERCEDES
8-76*	190	20	22,7		FORD
8-78	215	21	24,1		RENAULT
8-80	200	18	20,9		CITROEN
8-82	215	23	1"		PEUGEOT
8-84*	200	24	20,4		ROVER, SEAT
8-88*	215	20	22,5		HYUNDAI
8-90*	215	26	28,7		MERCEDES
8-92*	200	26	28,7		MERCEDES
8-94*	215	26	28,7		MERCEDES
8-96*	215	10	29		MERCEDES
8-98*	215	17	19		SAAB
8-100*	215	17	19		SAAB
8-102*	215	17	19		SAAB
8-104*	215	17	19,9		SAAB
8-106*	200	20	18,1		SUZUKI
8-108*	215	20	22,4		SUZUKI
8-110*	215	20	22,5		MITSUBISHI
8-112*	200	24	25,6		NISSAN
8-114*	215	24	25		ROVER
8-116*	215	24	25		ROVER

RELACIÓN DE DISCOS MEDIDAS MODELOS

REFERENCIA	MEDIDAS	MODELOS	REFERENCIA	MEDIDAS	MODELOS
	Ø Nº Ø EXTERIOR ESTRIAS FONDO ESTRIA			Ø Nº Ø EXTERIOR ESTRIAS FONDO ESTRIA	
8-118*	215 x 23 x 26	ROVER	9-16*	228 x 23 x 24,3	AUDI
8-120*	215 x 24 x 25	ROVER	9-18*	228 x 10 x 29	BMW
8-122*	200 x 20 x 22	ROVER	9-20*	228 x 10 x 29	BMW
8-124*	215 x 24 x 25	ROVER	9-22*	228 x 10 x 29	BMW
8-128*	215 x 21 x 28,8	TOYOTA	9-24*	228 x 10 x 29	BMW
8-130*	215 x 21 x 29	TOYOTA	9-26*	228 x 10 x 29	BMW
8-132*	215 x 28 x 20,2	VOLKSWAGEN	9-27	230 x 10 x 29	LAURAK
8-134*	200 x 24 x 20,4	VOLKSWAGEN	9-27/1	200 x 10 x 29	LAURAK
8-136*	200 x 24 x 20,4	VOLKSWAGEN	9-28*	228 x 10 x 29	BMW
8-140*	200 x 24 x 20,4	VOLKSWAGEN	9-29	225 x 10 x 1 3/4"	MASSEY FERGUSSON-
8-142*	210 x 24 x 20,4	VOLKSWAGEN		SACA	
8-144*	210 x 28 x 22,2	VOLKSWAGEN	9-30*	230 x 10 x 29	DAF
8-146*	200 x 24 x 20,4	VOLKSWAGEN	9-31	225 x 10 x 1 3/8"	DUMPERSA-OLSUC
8-148*	200 x 28 x 22,2	VOLKSWAGEN			MASSEYFERGUSSONS
8-150*	210 x 24 x 20,4	VOLKSWAGEN	9-32*	229 x 23 x 26,2	DAF
8-152*	215 x 24 x 20,4	VOLKSWAGEN	9-34*	230 x 10 x 29	DAF
8-154*	200 x 24 x 20,4	VOLKSWAGEN	9-38*	220 x 23 x 26	FORD
8-156*	215 x 24 x 20,4	VOLKSWAGEN	9-40*	225 x 24 x 26	HONDA
8-158*	215 x 24 x 20,4	VOLKSWAGEN	9-42*	220 x 20 x 22	HONDA
8-162*	215 x 22 x 25	VOLVO	9-44	232 x 10 x 1 1/8"	AVIA-EBRO-
8-164*	215 x 10 x 25,4	VOLVO			LAND ROVER-NISSAN
8-166*	215 x 22 x 25	VOLVO	9-44/1	235 x 23 x 25,4	TALBOT
8-170*	200 x 20 x 23	VOLVO	9-44/2	215 x 23 x 26,2	TALBOT
8-172*	215 x 24 x 20,4	VOLVO	9-45	232 x 10 x 1 1/8"	
8-174*	200 x 26 x 22	VOLVO	9-46*	220 x 24 x 26	HONDA
8-176*	215 x 26 x 22	VOLVO	9-48	229 x 10 x 1 1/8"	SAVA
8-178*	207 x 26 x 22	VOLVO	9-49	229 x 10 x 1 1/8"	
8-180*	215 x 18 x 21	CITROEN, PEUGEOT	9-50	232 x 10 x 1 3/8"	EBRO
8-182*	215 x 21 x 24,1	CITROEN	9-51*	228 x 26 x 28,7	MERCEDES
8-184*	200 x 18 x 20,8	CITROEN	9-52*	220 x 24 x 25	HONDA
8-190*	200 x 14 x 18,6	OPEL	9-53	225 x 17 x 32	PASQUALI
8-192*	215 x 24 x 20,7	OPEL	9-56*	228 x 24 x 25,2	HONDA
8-194*	215 x 24 x 20,7	OPEL	9-58*	220 x 24 x 26	HONDA
8-196*	215 x 24 x 20,7	OPEL	9-60	228 x 21 x 24,1	CITROEN-FIAT-
8-198*	215 x 10 x 29	PEUGEOT			PEUGEOT
8-200*	215 x 10 x 29	PEUGEOT	9-62	235 x 10 x 15/16"	EBRO
8-204*	215 x 10 x 29	MERCEDES	9-64	232 x 10 x 15/16"	EBRO
8-206*	215 x 10 x 29	MERCEDES	9-66	228 x 10 x 29	MERCEDES
8-207	215 x 14 x 25		9-66/L	235 x 23 x 26,4	LAND ROVER
8-207 PLCE	215 x 14 x 25		9-70*	225 x 24 x 26	ROVER
8-208	215 x 8 x 25		9-72*	228 x 24 x 25,2	ROVER
8-209	200 x 10 x 29		9-74*	228 x 17 x 19	SAAB
8-210	215 x 8 x 25		9-76*	225 x 24 x 24,8	SUBARU
8-211*	200 x 10 x 32	DEUTZ	9-78*	225 x 24 x 24,8	SUBARU
8-212*	193 x 23 x 38	JOHN DEERE	9-80*	225 x 20 x 22,5	MITSUBISHI
8-213*	200 x 10 x 1"	BENFORD	9-82*	225 x 23 x 26	MITSUBISHI
8-214	200 x 10 x 1"		9-84*	225 x 23 x 26	MITSUBISHI
8-215*	200 x 10 x 26	DEUTZ	9-86*	225 x 23 x 26	MITSUBISHI
8-217*	200 x 10 x 32	DEUTZ	9-88*	225 x 21 x 22,5	MITSUBISHI
8-219*	200 x 10 x 26	DEUTZ	9-100*	225 x 24 x 25,4	NISSAN
8-221*	215 x 10 x 1 1/4"	JOHN DEERE	9-102*	228 x 24 x 25,2	ROVER
.....			9-104*	229 x 23 x 26	ROVER
9-02*	228 x 20 x 23	ALFA ROMEO	9-106*	225 x 21 x 28,6	TOYOTA
9-03*	225 x 10 x 29	SAME	9-108*	225 x 21 x 28,8	TOYOTA
9-04*	228 x 23 x 24,3	AUDI	9-110*	225 x 21 x 28,8	TOYOTA
9-06*	228 x 24 x 20,4	AUDI	9-112*	236 x 21 x 29,8	TOYOTA
9-08*	228 x 23 x 24,3	AUDI	9-114*	228 x 28 x 22,2	VOLKSWAGEN
9-10*	228 x 24 x 20,4	AUDI	9-116*	228 x 28 x 22,2	VOLKSWAGEN
9-12*	215 x 24 x 20,4	AUDI	9-118*	228 x 28 x 22,2	VOLKSWAGEN
9-14*	228 x 24 x 20,4	AUDI	9-120*	228 x 28 x 22,2	VOLKSWAGEN

RELACIÓN DE DISCOS MEDIDAS MODELOS

REFERENCIA	MEDIDAS	MODELOS	REFERENCIA	MEDIDAS	MODELOS
	Ø N° Ø EXTERIOR ESTRIAS FONDO ESTRIA			Ø N° Ø EXTERIOR ESTRIAS FONDO ESTRIA	
9-122*	228 x 28 x 22,2	VOLKSWAGEN	10-03/4	280 x 10 x 1 3/4"	BARREIROS-DAVID BROWN
9-124*	228 x 24 x 20,4	VOLKSWAGEN	10-03/7	250 x 15 x 26	JOHN DEERE
9-126*	228 x 28 x 22,2	VOLKSWAGEN	10-06*	250 x 10 x 29	JOHN DEERE
9-128*	228 x 23 x 24,2	VOLKSWAGEN	10-08*	250 x 10 x 32	JOHN DEERE
9-130*	228 x 23 x 24,2	VOLKSWAGEN	10-09*	250 x 8 x 50	JOHN DEERE
9-132*	225 x 21 x 28,8	VOLKSWAGEN	10-10*	240 x 10 x 29	ALFA ROMEO
9-134*	225 x 21 x 28,8	VOLKSWAGEN	10-11*	250 x 10 x 1 1/4"	JOHN DEERE
9-136*	236 x 21 x 29,8	VOLKSWAGEN	10-12*	240 x 10 x 29	BMW
9-138*	228 x 24 x 20,4	VOLKSWAGEN	10-14	254 x 10 x 1 3/8"	SAVA-ARO-JOHN DEERE-FIAT
9-140*	228 x 24 x 20,4	VOLKSWAGEN	10-14/1	254 x 10 x 1 3/8"	O.M.
9-142*	228 x 22 x 25	VOLVO	10-15	254 x 10 x 1 3/8"	SAVA
9-144	254 x 10 x 32	FIAT	10-15/A	254 x 10 x 1 3/8"	JOHN DEERE
9-144/1	254 x 10 x 1 1/4"	LAND ROVER-SAVA-B.J.R.	10-16	254 x 10 x 7/8"	AUSA
9-145	254 x 10 x 32	BARREIROS-FIAT	10-17	250 x 10 x 32	MERCEDES
9-145/2	302 x 10 x 1 1/4"	JOHN DEERE	10-18	225 x 23 x 39,8	BARREIROS-JOHN DEERE
9-145/2 PLCE	302 x 10 x 1 1/4"	JOHN DEERE	10-19	225 x 23 x 39,8	BARREIROS-JOHN DEERE-MOTRANSA
9-146	232 x 24 x 20,5	RENAULT	10-20	242 x 10 x 1 1/8"	LAND ROVER
9-148	232 x 10 x 32	RENAULT	10-21	242 x 10 x 1 1/8"	LAND ROVER-NISSAN
9-150*	228 x 22 x 25	VOLVO	10-22	242 x 10 x 1 1/8"	AGRIA
9-152*	228 x 22 x 25	VOLVO	10-23	254 x 14 x 25	NISSAN
9-154*	228 x 22 x 25	VOLVO	10-24*	242 x 24 x 25,76	SAME
9-156*	228 x 24 x 20,4	VOLKSWAGEN	10-25*	250 x 14 x 25	IVECO
9-158*	228 x 21 x 24	CITROEN	10-26	242 x 10 x 29	SAME
9-160*	220 x 17 x 20	FORD	10-27*	250 x 20 x 40	SAMA RENAULT
9-162*	220 x 17 x 20	FORD	10-27/1	250 x 10 x 45	LAVERDA-POCLAIN-SAMA-RENAULT
9-164*	230 x 14 x 25	OPEL	10-27/2	250 x 10 x 35	POCLAIN
9-166*	228 x 24 x 20,7	OPEL	10-27/2 PLCE	250 x 10 x 35	SAMA RENAULT
9-168*	228 x 21 x 24,1	RENAULT	10-27/3	250 x 33 x 37	MASSEY FERGUSON
9-170*	228 x 10 x 29	MERCEDES	10-27/4	250 x 10 x 1 1/8"	MASSEY FERGUSON
9-172*	228 x 10 x 29	MERCEDES	10-27/5	251 x 10 x 1 3/4"	NISSAN
9-174*	228 x 10 x 27	MERCEDES	10-27/9	251 x 25 x 1 5/8"	FENWICH
9-178*	228 x 10 x 27	MERCEDES	10-28*	242 x 24 x 25,76	FENWICH
9-180*	235 x 27 x 45	JOHN DEERE	10-29	250 x 10 x 30	FORD
9-184*	228 x 10 x 29	MERCEDES	10-29 PLCE	250 x 10 x 30	SAME
9-185*	225 x 17 x 32	DEUTZ	10-30*	242 x 23 x 25,4	IVECO
9-186*	230 x 10 x 35	MERCEDES	10-31*	255 x 22 x 45	BMW
9-187	232 x 10 x 1"	BENFORD	10-32*	267 x 10 x 29	AUSA
9-188	232 x 10 x 1"		10-34*	240 x 10 x 29	DAF
9-189*	225 x 20 x 40	DEUTZ	10-36	240 x 10 x 7/8"	DAF
9-190*	228 x 21 x 24,1	CITROEN	10-38*	240 x 23 x 26,2	DAF
9-191*	225 x 10 x 26	DEUTZ	10-40*	240 x 23 x 26,2	DAF
9-192*	235 x 23 x 38	JOHN DEERE	10-42*	240 x 23 x 26,2	FORD
9-193*	225 x 10 x 40	DEUTZ	10-44*	240 x 23 x 26,2	MERCEDES
9-197*	225 x 10 x 40	DEUTZ	10-46*	240 x 23 x 26	ROVER
9-199*	225 x 10 x 32	DEUTZ	10-48*	240 x 26 x 28,7	MERCEDES
9-200*	225 x 27 x 45	BARREIROS	10-50*	241 x 23 x 26	ROVER
9-201*	225 x 8 x 42	DEUTZ	10-51*	240 x 26 x 28,7	MERCEDES
9-203*	228 x 17 x 32	DEUTZ	10-52*	240 x 10 x 28,6	ROVER
9-205*	225 x 10 x 26	JOHN DEERE	10-54*	241 x 23 x 26	ROVER
9-207*	225 x 10 x 32	MASSEY FERGUSON	10-56*	240 x 14 x 29,3	MITSUBISHI
9-209*	225 x 10 x 29	MASSEY FERGUSON	10-58*	240 x 24 x 25,4	NISSAN
9-211*	225 x 10 x 35	MASSEY FERGUSON	10-60*	241 x 23 x 26	ROVER
9-213*	230 x 20 x 40	SAME	10-62*	240 x 21 x 30	TOYOTA
10-03/1	280 x 10 x 29	JOHN DEERE	10-64*	240 x 21 x 28,8	TOYOTA
10-03/3	276 x 15 x 26	JOHN DEERE-BARREIROS-MOTRANSA			
10-03/3 PLCE	276 x 15 x 26				

RELACIÓN DE DISCOS MEDIDAS MODELOS

REFERENCIA	MEDIDAS	MODELOS	REFERENCIA	MEDIDAS	MODELOS
	Ø Nº Ø EXTERIOR ESTRIAS FONDO ESTRIA			Ø Nº Ø EXTERIOR ESTRIAS FONDO ESTRIA	
10 - 66 *	240 x 21 x 29,8	TOYOTA	11 - 43/2	280 x 10 x 1 3/8"	EBRO KUBOTA
10 - 68 *	250 x 10 x 32	MAGIRUS,IVECO	11 - 45	280 x 10 x 1 1/2"	FENWICH
10 - 69*	250 x 10 x 1 3/8"	JOHN DEERE	11 - 45 PLCE	280 x 10 x 1 1/2"	FENWICH
10 - 69 PLCE	250 X 10 X 1 3/8"	JOHN DEERE	11 - 47 *	273 x 10 x 1 1/8"	MASSEY FERGUSON
10 - 70 *	240 x 22 x 25	VOLVO	11 - 48	276 x 10 x 1 3/8"	EBRO-IVECO-SAVA-
10 - 71 *	250 x 17 x 32	DEUTZ			DITER-O.M.-HOLMAN
10 - 72	254 x 10 x 1"			I	BERICA-JOHN DEERE
10 - 73 *	250 x 10 x 29	DEUTZ	11 - 49	280 x 10 x 1 3/8"	EBRO KUBOTA-
10 - 75 *	250 x 8 x 42	DEUTZ			HOLMAN IBERICA-
10 - 77 *	250 x 10 x 32	DEUTZ			ROMERO-JOHN DEERE-
10 - 79 *	250 x 10 x 32	DEUTZ			SOLSUC
10 - 79S/F	250 x 24 x 65,50		11 - 49 PLCE	280 x 10 x 1 3/8"	
.....			11 - 49/D	280 x 10 x 1 3/8"	AVIA-MOTRANSA
11 - 02	280 x 10 x 29	SAVA	11 - 49/H	280 x 10 x 1 3/8"	
11 - 03	280 x 10 x 29	SAVA	11 - 50	276 x 10 x 7/8"	AUSA
11 - 03/2	280 x 8 x 50	JOHN DEERE	11 - 51/1	280 x 10 x 45	EBRO-SAMA RENAULT
11 - 03/5	302 x 15 x 26	JOHN DEERE	11 - 51/2	280 x 33 x 37	EBRO-SAMA RENAULT
11 - 03/5 PLCE	302 x 15 x 26	JOHN DEERE	11 - 53 *	280 x 28 x 45	ZETOR
11 - 05 *	280 x 10 x 32	MAGIRUS	11 - 55 *	280 x 28 x 45	ZETOR
11 - 07 *	280 x 10 x 40	MAN	11 - 56	267 x 23 x 26,4	LAND ROVER
11 - 09 *	280 x 10 x 35	MERCEDES	11 - 57 *	280 x 16 x 25	ZETOR
11 - 10 *	275 x 10 x 28	TOYOTA	11 - 59 *	280 x 16 x 25	ZETOR
11 - 11 *	280 x 19 x 29	SAME	11 - 61 PLCE *	280 x 16 x 25	ZETOR
11 - 13*	280 x 14 x 25	SAME	11 - 69 *	280 x 18 x 28	ZETOR
11 - 14 *	280 x 10 x 40	MAGIRUS	11 - 70	302 x 10 x 1 1/2"	RENAULT
11 - 16 *	280 x 10 x 32	MAGIRUS,IVECO	11 - 70/3	327 x 10 x 1 1/2"	RENAULT
11 - 18 *	280 x 28 x 29,5	MAN	11 - 70/5	302 x 10 x 32	RENAULT
11 - 20	280 x 10 x 1 1/8"	AVIA	11 - 71	302 x 10 x 1 1/2"	AVIA-RENAULT-SACA
11 - 20/1	280 x 10 x 1 1/8"	RENAULT	11 - 71/2	302 x 10 x 1 1/2"	RENAULT
11 - 20/4	280 x 10 x 1 1/8"	SACA	11 - 73 *	280 x 18 x 28	ZETOR
11 - 21	280 x 10 x 1 1/8"		11 - 75 *	280 x 18 x 28	ZETOR
11 - 21/B	280 x 10 x 1 1/8"	BARREIROS	11 - 77 *	280 x 18 x 28	ZETOR
11 - 21/D	280 x 10 x 1 1/8"	AVIA-RENAULT-	11 - 77 PLCE *	280 x 18 x 28	ZETOR
		DEUTZ	11 - 78 *	280 x 8 x 42	DEUTZ
11 - 21/1 D	280 x 10 x 1 1/8"		11 - 79	280 x 24 x 65,50	
11 - 21/1	280 x 10 x 1 1/8"		11 - 80 PLCE	280 x 20 x 40	DEUTZ
11 - 21/2	280 x 10 x 1 1/8"	DEUTZ	11 - 81 *	280 x 10 x 32	DEUTZ
11 - 21/4	280 x 10 x 1 1/8"	SACA	11 - 83 *	280 x 17 x 32	DEUTZ
11 - 22 *	280 x 10 x 35	MERCEDES	11 - 84 *	280 x 20 x 40	DEUTZ
11 - 25	276 x 10 x 35	FENWICH-POCLAIN-	11 - 85 *	280 x 16 x 35	DEUTZ
		MAQUINARIA	11 - 86 *	280 x 10 x 1 1/2"	IVECO
11 - 25 PLCE	276 x 10 x 35	FENWICH-LAURAK-	11 - 87 *	280 x 20 x 40	DEUTZ
		POCLAIN	11 - 88 *	280 x 10 x 1 3/4"	IVECO
11 - 25/D	280 x 10 x 35	LAURAK	11 - 89 *	295 x 8 x 42	DEUTZ
11 - 26	280 x 10 x 35	MERCEDES-LAURAK	11 - 90 *	280 x 10 x 40	IVECO
11 - 27 *	280 x 10 x 35	MERCEDES	11 - 91 *	280 x 10 x 32	DEUTZ
11 - 29 *	280 x 10 x 35	SAME	11 - 92 *	280 x 15 x 26	JOHN DEERE
11 - 31 *	262 x 22 x 45	SAME	11 - 92 PLCE	280 x 15 x 26	JOHN DEERE
11 - 33 PLCE *	280 x 20 x 40	SAME	11 - 93 PLCE	295 x 23 x 48	DEUTZ
11 - 35	275 x 10 x 35	LAVERDA	11 - 94 *	280 x 10 x 1 1/4"	JOHN DEERE
11 - 36	280 x 10 x 1 1/2"	RENAULT-SAVA	11 - 95 *	280 x 10 x 29	JOHN DEERE
11 - 37	280 x 10 x 1 1/2"	PERKINS-RENAULT-	11 - 96 *	280 x 10 x 1 1/4"	JOHN DEERE
		SAVA-BARREIROS	11 - 97 *	280 x 10 x 25	MASSEY FERGUSON
11 - 37 PLCE	280 x 10 x 1 1/2"	BARREIROS	11 - 98 *	280 x 14 x 40	MASSEY FERGUSON
11 - 37/D	280 x 10 x 1 1/2"		11 - 99 *	278 x 10 x 1 1/8"	MASSEY FERGUSON
11 - 39	276 x 10 x 32	BARREIROS	11 - 100 PLCE *	280 x 14 x 40	MASSEY FERGUSON
11 - 39 PLCE	276 x 10 x 32		11 - 101 PLCE *	280 x 20 x 40	SAME
11 - 39 /D	276 x 10 x 32		11 - 103 *	250 x 14 x 1"	SAME
11 - 41/1	280 x 10 x 1 3/8"	EBRO KUBOTA		
11 - 43	280 x 10 x 1 1/8"		12 - 02/2	302 x 10 x 1 1/2"	AVIA-SAVA

RELACIÓN DE DISCOS MEDIDAS MODELOS

REFERENCIA	MEDIDAS	MODELOS	REFERENCIA	MEDIDAS	MODELOS
	Ø Nº Ø EXTERIOR ESTRIAS FONDO ESTRIA			Ø Nº Ø EXTERIOR ESTRIAS FONDO ESTRIA	
12 - 03/1	302 x 10 x 1 1/2"	AVIA	12 - 71 *	310 x 21 x 45	DEUTZ
12 - 03/4	302 x 10 x 35	LAVERDA	12 - 72 *	310 x 10 x 1 1/2"	MAGIRUS
12 - 05 *	310 x 10 x 40	MAGIRUS	12 - 73 PLCE	310 x 21 x 45	DEUTZ
12 - 07 *	295 x 10 x 40	MAGIRUS	12 - 74 *	310 x 10 x 1 1/2"	MAGIRUS
12 - 09 *	310 x 10 x 40	MAN	12 - 75 *	310 x 16 x 30	DEUTZ
12 - 10/2	302 x 10 x 1 3/8"	AVIA-SAVA	12 - 76 *	310 x 10 x 1 1/2"	MAGIRUS,IVECO
12 - 10/4	302 x 10 x 1 3/8"	AVIA-EBRO	12 - 77 *	310 x 8 x 42	DEUTZ
12 - 10/6	310 x 10 x 1 3/8"	EBRO-NISSAN	12 - 78 *	320 x 10 x 29	SAME
12 - 11/2	302 x 10 x 1 3/8"	AVIA	12 - 79 *	310 x 10 x 1 3/8"	JOHN DEERE
12 - 11/3	302 x 10 x 1 1/8"	MASSEY FERGUSSON	12 - 80 *	330 x 10 x 1 1/2"	MAGIRUS
12 - 11/3 PLCE	302 x 10 x 1 1/8"	MASSEY FERGUSSON	12 - 82 *	310 x 10 x 1 3/4"	MAN
12 - 11/5	302 x 10 x 1 3/8"	AVIA	12 - 84 *	310 x 10 x 35	MERCEDES
12 - 13 *	295 x 10 x 35	MERCEDES	12 - 88 *	310 x 10 x 35	MERCEDES
12 - 15	302 x 10 x 1 1/2"	FENWICH	12 - 90 *	330 x 10 x 35	MERCEDES
12 - 15 PLCE	302 x 10 x 1 1/2"	FENWICH	12 - 98 *	330 x 24 x 50	SAME
12 - 17 *	295 x 10 x 35	MERCEDES	12 - 100 *	302 x 21 x 29	MASSEY FERGUSSON
12 - 19 *	290 x 10 x 29	SAME	12 - 101 *	310 x 16 x 30	MASSEY FERGUSSON
12 - 21 *	310 x 22 x 45	SAME	12 - 105 *	302 x 10 x 1 1/8"	MASSEY FERGUSSON
12 - 23 *	325 x 24 x 50	SAME	12 - 107 *	302 x 21 x 29	MASSEY FERGUSSON
12 - 23 PLCE *	325 x 24 x 50	SAME	12 - 109 *	310 x 10 x 1 1/2"	RENAULT
12 - 25 *	290 x 10 x 35	SAME	12 - 111 *	310 x 20 x 40	SAME
12 - 27 *	302 x 28 x 45	ZETOR	12 - 117 *	310 x 14 x 1"	SAME
12 - 29 *	305 x 10 x 1 3/8"	JOHN DEERE	12 - 119 *	310 x 18 x 28	ZETOR
12 - 29 PLCE	305 x 10 x 1 3/8"	JOHN DEERE			
12 - 29/1 *	327 x 22 x 35	ZETOR	13 - 03 *	350 x 24 x 50	SAME
12 - 31 PLCE *	327 x 22 x 35	ZETOR	13 - 03 PLCE *	350 x 24 x 50	SAME
12 - 33 PLCE *	327 x 22 x 35	ZETOR	13 - 04 *	350 x 10 x 40	MAGIRUS
12 - 35 *	330 x 18 x 30	ZETOR	13 - 05 *	350 x 17 x 32	SAME
12 - 37 *	330 x 18 x 30	ZETOR	13 - 06 *	350 x 10 x 40	MAGIRUS,IVECO
12 - 43	327 x 18 x 50	SAMA RENAULT	13 - 07 *	350 x 22 x 35	ZETOR
12 - 45 PLCE *	330 x 18 x 30	ZETOR	13 - 07 PLCE *	350 x 22 x 35	ZETOR
12 - 47 PLCE *	330 x 18 x 30	ZETOR	13 - 08 *	350 x 10 x 1 1/2"	MAGIRUS
12 - 49	310 x 10 x 1 3/8"	PEGASO-SAVA	13 - 09 PLCE *	350 x 24 x 50	SAME
12 - 50 *	300 x 10 x 1 1/4"	JOHN DEERE	13 - 10	327 x 10 x 1 1/2"	SAVA-SEDDON-DITER
12 - 52	327 x 10 x 1 3/8"	EBRO	13 - 11	327 x 10 x 1 1/2"	
12 - 52/1	327 x 10 x 1 1/2"	AVIA	13 - 12 *	350 x 10 x 1 3/4"	MAGIRUS,IVECO
12 - 52/2	327 x 10 x 1 1/2"	AVIA-EBRO	13 - 14 *	350 x 10 x 1 1/2"	MAGIRUS
12 - 53	325 x 10 x 1 3/8"	EBRO KUBOTA- ROMERO	13 - 16 *	350 x 10 x 52	MAGIRUS,IVECO
12 - 53 PLCE	325 x 10 x 1 3/8"	EBRO KUBOTA- ROMERO	13 - 18 *	330 x 10 x 1 1/2"	IVECO
12 - 53/1	327 x 10 x 1 1/2"	MOTRANSA	13 - 20 *	350 x 21 x 42	MAN
12 - 53/1 PLCE	327 x 10 x 1 1/2"	MOTRANSA	13 - 22 *	350 x 10 x 1 1/2"	MAN
12 - 53/3	327 x 10 x 1 3/8"	LEVANTE	13 - 24 *	350 x 10 x 1 3/4"	MAN
12 - 54	305 x 10 x 1 1/2"	IVECO	13 - 26 *	350 x 10 x 40	MERCEDES
12 - 56	276 x 23 x 26,4	LAND ROVER	13 - 28 *	350 x 10 x 45	MERCEDES
12 - 57	310 x 10 x 45	POCLAIN	13 - 30 *	350 x 10 x 1 3/4"	MERCEDES
12 - 57 PLCE	310 x 10 x 45	POCLAIN	13 - 31	340 x 10 x 35	PEGASO
12 - 59	310 x 10 x 1 1/8"	BARREIROS	13 - 32 *	350 x 10 x 1 3/4"	MERCEDES
12 - 59 PLCE	310 x 10 x 1 1/8"	BARREIROS	13 - 34 *	350 x 10 x 40	MERCEDES,IVECO
12 - 60	302 x 10 x 1 1/2"	PEGASO	13 - 36 *	350 x 10 x 1 3/4"	MERCEDES
12 - 61	302 x 10 x 1 1/2"		13 - 38 *	350 x 24 x 50	SAME
12 - 62 *	267 x 10 x 29	ALFA ROMEO	13 - 40 PLCE	320 x 15 x 26	JOHN DEERE
12 - 63	310 x 10 x 1 3/8"		13 - 41	340 x 10 x 35	PEGASO
12 - 64 *	267 x 10 x 28,6	ROVER	13 - 42 *	330 x 10 x 1 1/4"	JOHN DEERE
12 - 66 *	267 x 23 x 26	ROVER	13 - 43	340 x 14 x 63	PEGASO
12 - 67 PLCE	310 x 10 x 1 1/8"	BARREIROS	13 - 44 *	320 x 10 x 1 1/4"	JOHN DEERE
12 - 68 *	267 x 23 x 26	ROVER	13 - 44 PLCE	320 x 10 x 1 1/4"	JOHN DEERE
12 - 68 PLCE	310 x 21 x 45	DEUTZ	13 - 45	350 x 10 x 1 3/4"	RENAULT
12 - 69 *	310 x 16 x 35	DEUTZ	13 - 46 PLCE	327 x 10 x 1 1/4"	JOHN DEERE
			13 - 48 PLCE	320 x 10 x 1 1/4"	JOHN DEERE
			13 - 50 PLCE	327 x 10 x 1 1/4"	JOHN DEERE

RELACIÓN DE DISCOS MEDIDAS MODELOS

REFERENCIA	MEDIDAS	MODELOS	REFERENCIA	MEDIDAS	MODELOS
	Ø Nº Ø EXTERIOR ESTRIAS FONDO ESTRIA			Ø Nº Ø EXTERIOR ESTRIAS FONDO ESTRIA	
13 - 64	350 x 10 x 1 1/2"	AVIA-LEYLAND- PEGASO-VOLVO- SEDDON	14 - 03 *	380 x 10 x 40	MAGIRUS
			14 - 05 *	350 x 8 x 42	DEUTZ
13 - 64/1	350 x 10 x 1 1/2"	PERKINS	14 - 06 *	380 x 10 x 40	MAGIRUS,IVECO
13 - 64/3	350 x 10 x 2"	FIAT	14 - 07 *	380 x 22 x 35	ZETOR
13 - 64/4	350 x 10 x 1 1/2"	PERKINS	14 - 07 PLCE *	380 x 22 x 35	ZETOR
13 - 64/5	380 x 10 x 1 3/4"	PEGASO-SCANIA-FIAT	14 - 08 *	380 x 10 x 1 3/4"	MAGIRUS
13 - 64/6	350 x 10 x 1 1/2"	EBRO	14 - 10 *	380 x 10 x 45	MAGIRUS
13 - 64/7	350 x 10 x 1 1/2"	EBRO	14 - 12 *	380 x 10 x 1 3/4"	MAGIRUS
13 - 64/9	350 x 10 x 1 3/4"	EBRO	14 - 14 PLCE	350 x 10 x 1 3/8	JCB-BAMFORD
13 - 64/R	350 x 10 x 40	MERCEDES-MAN- PEGASO	14 - 15	380 x 10 x 1 3/4"	EBRO
			14 - 15 PLCE	380 x 10 x 1 3/4"	
13 - 65	350 x 10 x 1 1/2"	PEGASO	14 - 16 *	380 x 10 x 1 3/4"	PEGASO
13 - 65/A	350 x 10 x 1 1/2"	RENAULT	14 - 17 PLCE *	380 x 10 x 1 3/4"	EBRO
13 - 67	350 x 10 x 1 3/4"	RENAULT	14 - 18 *	380 x 10 x 1 3/4"	MAN
13 - 67 PLCE	350 x 10 x 1 3/4"	RENAULT	14 - 20 *	380 x 10 x 45	MAN
13 - 68	350 x 10 x 1 3/4"	RENAULT	14 - 22 *	380 x 10 x 45	MAN
13 - 68 PLCE	350 x 10 x 1 3/4"	RENAULT	14 - 24 *	380 x 10 x 40	MAN
13 - 69	350 x 10 x 1 3/4"	RENAULT	14 - 26 *	380 x 10 x 1 3/4"	MERCEDES-VOLVO
13 - 69 PLCE	350 x 10 x 1 3/4"	RENAULT	14 - 28 *	380 x 26 x 55	MAN
13 - 70	350 x 10 x 1 3/4"	RENAULT	14 - 30 *	380 x 10 x 1 3/4"	MAN
13 - 70 PLCE *	350 x 10 x 1 3/4"	RENAULT	14 - 32 *	380 x 10 x 1 3/4"	MAN
13 - 78	350 x 10 x 40	MERCEDES-MAN	14 - 34 *	380 x 10 x 1 3/4"	MERCEDES
13 - 80 *	350 x 10 x 1 3/4"	VOLVO	14 - 35	380 x 10 x 45	
13 - 81	350 x 10 x 40	BARREIROS	14 - 35/1	380 x 10 x 45	SAVA
13 - 81 PLCE	350 x 10 x 40	BARREIROS	14 - 36 *	380 x 10 x 45	
13 - 81/1	380 x 10 x 1 1/2"	RENAULT	14 - 36/R *	380 x 10 x 45	MERCEDES-MAN
13 - 81/1 PLCE	380 x 10 x 1 1/2"	RENAULT	14 - 38 *	380 x 10 x 1 3/4"	MERCEDES
13 - 81/2	380 x 10 x 40	RENAULT	14 - 40 *	380 x 10 x 1 3/4"	VOLVO
13 - 81/5	380 x 10 x 1 3/4"	RENAULT	14 - 42 *	380 x 10 x 1 3/4"	VOLVO
13 - 81/5 PLCE	380 x 10 x 1 3/4"	RENAULT	14 - 44 *	380 x 10 x 52	MERCEDES
13 - 81/7	350 x 10 x 40	BARREIROS	14 - 46 *	380 x 10 x 2"	MERCEDES
13 - 81/7 PLCE	350 x 10 x 40	BARREIROS	14 - 47	370 x 14 x 63	PEGASO
13 - 81/8	380 x 10 x 1 3/4"	RENAULT	14 - 48 *	380 x 10 x 45	MERCEDES
13 - 81/8 PLCE	380 x 10 x 1 3/4"	RENAULT	14 - 49	367 x 10 x 1 1/2"	PEGASO
13 - 82 *	350 x 10 x 1 3/4"	VOLVO	14 - 50 *	380 x 10 x 1 3/4"	MERCEDES
13 - 83	380 x 10 x 1 3/4"	PEGASO	14 - 52 *	380 x 10 x 1 3/4"	MERCEDES
13 - 83 PLCE	380 x 10 x 1 3/4"	PEGASO	14 - 54 *	380 x 10 x 52	MERCEDES
13 - 84 *	350 x 10 x 2"	VOLVO	14 - 56 *	380 x 10 x 1 3/4"	MERCEDES
13 - 85	380 x 10 x 1 3/4"	PEGASO	14 - 58 *	380 x 10 x 1 3/4"	MERCEDES
13 - 85 PLCE	380 x 10 x 1 3/4"	PEGASO	14 - 60 *	380 x 10 x 1 5/8"	VOLVO
13 - 86 *	350 x 10 x 2"	VOLVO	14 - 62 *	380 x 10 x 1 3/4"	MERCEDES
13 - 87	380 x 10 x 2"	PEGASO	14 - 64 *	380 x 10 x 2"	MERCEDES
13 - 87 PLCE	380 x 10 x 2"	PEGASO	14 - 64/8	380 x 10 x 1 3/4"	EBRO
13 - 89	380 x 10 x 2"	PEGASO	14 - 66 *	380 x 10 x 1 3/4"	MAN
13 - 89 PLCE	380 x 10 x 2"	PEGASO	14 - 68 *	380 x 10 x 1 3/4"	MAN
13 - 91 PLCE	350 x 16 x 43,5	EBRO KUBOTA	14 - 70 *	350 x 10 x 1 3/4"	MAN
13 - 91/1PLCE	350 x 16 x 43,5	EBRO KUBOTA	14 - 72 *	380 x 10 x 2"	MERCEDES
13 - 94/R	350 x 10 x 45	MAN	14 - 73 PLCE	350 x 23 x 2"	MASSEY FERGUSON
13 - 95 PLCE	327 x 23 x 48	DEUTZ	14 - 74 *	380 x 10 x 1 3/4"	DAF
13 - 97PLCE	327 x 10 x 1 3/8"	JOHN DEERE	14 - 75PLCE	350 x 24 x 50	SAME
13 - 98 *	327 x 21 x 29	MASSEY FERGUSON	14 - 76 *	350 x 16 x 45	RENAULT
13 - 99 *	327 x 10 x 1 1/8"	MASSEY FERGUSON			
13 - 100 PLCE	327 x 21 x 29	MASSEY FERGUSON	15 - 02 *	380 x 10 x 1 3/4"	IVECO
13 - 101 PLCE	327 x 10 x 1 1/8"	MASSEY FERGUSON	15 - 01 PLCE	380 x 8 x 42	DITER
13 - 103PLCE	330 x 23 x 48	MASSEY FERGUSON	15 - 03 *	380 x 18 x 50	RENAULT
13 - 105 *	327 x 16 x 30	MASSEY FERGUSON	15 - 04 *	380 x 10 x 40	MAGIRUS,IVECO
13 - 107PLCE	327 x 21 x 29	MASSEY FERGUSON	15 - 06 *	380 x 10 x 1 3/4"	IVECO
13 - 109 *	327 x 23 x 2"	MASSEY FERGUSON	15 - 08 *	380 x 16 x 45	RENAULT
13 - 109 PLCE	327 x 23 x 2"	MASSEY FERGUSON	15 - 36/R *	380 x 10 x 40	MERCEDES
			15 - 37 *	407 x 10 x 40	RENAULT

RELACIÓN DE DISCOS MEDIDAS MODELOS

REFERENCIA	MEDIDAS	MODELOS	REFERENCIA	MEDIDAS	MODELOS
	Ø Nº Ø EXTERIOR ESTRIAS FONDO ESTRIA			Ø Nº Ø EXTERIOR ESTRIAS FONDO ESTRIA	
16 - 02 *	420 x 10 x 1 3/4"	MAGIRUS	16 - 84 *	420 x 10 x 1 3/4"	MERCEDES
16 - 04 *	420 x 10 x 1 3/4"	MAGIRUS	16 - 86 *	420 x 10 x 1 3/4"	MERCEDES
16 - 06 *	420 x 10 x 1 3/4"	MAGIRUS	16 - 88 *	420 x 10 x 1 3/4"	MERCEDES
16 - 10 *	420 x 10 x 1 3/4"	MAGIRUS	16 - 90 *	430 x 10 x 1 3/4"	MERCEDES
16 - 12 *	400 x 10 x 2"	IVECO	16 - 92 *	430 x 10 x 2"	PEGASO-RENAULT
16 - 14 *	420 x 10 x 45"	MAN	16 - 94 *	420 x 10 x 1 3/4"	MAN
16 - 15	407 x 10 x 1 1/2"	RENAULT	16 - 96 *	420 x 10 x 1 3/4"	MERCEDES,RENAULT
16 - 16 *	420 x 10 x 1 3/4"	MAN	16 - 98 *	430 x 10 x 2"	MERCEDES
16 - 17	407 x 10 x 2"	RENAULT	16 - 100 *	430 x 10 x 1 3/4"	MERCEDES
16 - 18 *	420 x 10 x 1 3/4"	MAN			
16 - 20 *	400 x 10 x 1 3/4"	IVECO	17 - 01 *	430 x 16 x 45	RENAULT
16 - 22 *	420 x 10 x 2"	MERCEDES	17 - 02 *	430 x 10 x 2"	IVECO
16 - 24 *	420 x 10 x 1 3/4"	MERCEDES,IVECO	17 - 03 *	430 x 10 x 1 3/4"	RENAULT
16 - 26 *	420 x 10 x 45	MAN	17 - 04 *	420 x 10 x 52	IVECO
16 - 26/R *	420 x 10 x 1 3/4"	VOLVO	17 - 05 *	430 x 20 x 55	RENAULT
16 - 28 *	420 x 10 x 1 3/4"	PEGASO	17 - 06 *	420 x 10 x 45	IVECO
16 - 29	400 x 11 x 51,8	PEGASO	17 - 10 *	430 x 10 x 1 3/4"	RENAULT
16 - 29/A	400 x 10 x 40		17 - 08 *	430 x 10 x 2"	RENAULT
16 - 29/B	420 x 11 x 51,8	PEGASO			
16 - 29/C	400 x 11 x 51,8	PEGASO			
16 - 29/C PLCE	400 x 11 x 51,8	PEGASO			
16 - 29/D	420 x 11 x 51,8	PEGASO			
16 - 29/D PLCE	420 x 11 x 51,8	PEGASO			
16 - 29/H	400 x 10 x 1 3/4"	PEGASO			
16 - 29/H PLCE	400 x 10 x 1 3/4"				
16 - 29/L	420 x 10 x 1 3/4"	PEGASO-RENAULT			
16 - 29/L PLCE	420 x 10 x 1 3/4"	PEGASO			
16 - 30 *	420 x 10 x 1 3/4"	SCANIA			
16 - 31/A	420 x 10 x 2"	PEGASO-RENAULT			
16 - 31/A PLCE	420 x 10 x 2"	RENAULT-PEGASO			
16 - 31/B	420 x 10 x 45	RENAULT			
16 - 32 *	420 x 10 x 1 3/4"	MAN			
16 - 33	420 x 10 x 1 3/4"	RENAULT			
16 - 33 PLCE	420 x 10 x 1 3/4"	RENAULT			
16 - 34 *	420 x 26 x 55	MAN			
16 - 36 *	420 x 10 x 1 3/4"	VOLVO			
16 - 38 *	420 x 10 x 1 3/4"	MAN			
16 - 40 *	430 x 20 x 55,75	RENAULT			
16 - 42 *	430 x 10 x 2"	MAN			
16 - 44 *	430 x 10 x 2"	MAN			
16 - 46 *	420 x 10 x 1 3/4"	MAN			
16 - 48 *	430 x 10 x 2"	MAN			
16 - 50 *	430 x 22 x 45	SCANIA			
16 - 52 *	420 x 10 x 1 3/4"	DAF			
16 - 54 *	420 x 10 x 1 3/4"	DAF			
16 - 56 *	420 x 10 x 1 3/4"	MERCEDES,RENAULT			
16 - 58 *	420 x 10 x 2"	MERCEDES			
16 - 60 *	420 x 10 x 2"	VOLVO			
16 - 62 *	420 x 10 x 1 3/4"	MERCEDES			
16 - 64 *	420 x 10 x 1 3/4"	MERCEDES			
16 - 66 *	420 x 10 x 1 3/4"	MERCEDES			
16 - 68 *	420 x 10 x 2"	MERCEDES			
16 - 70 *	420 x 10 x 45	MERCEDES			
16 - 72 *	420 x 10 x 45	MERCEDES			
16 - 74 *	420 x 10 x 1 3/4"	MERCEDES			
16 - 76 *	420 x 10 x 52	MERCEDES			
16 - 78 *	420 x 10 x 1 3/4"	MERCEDES,IVECO			
16 - 80 *	420 x 10 x 1 3/4"	MERCEDES			
16 - 81 *	430 x 20 x 55,75	RENAULT			
16 - 82 *	430 x 10 x 1 3/4"	PEGASO-RENAULT			

CONJUNTOS DE PRESIÓN

REFERENCIA	Ø	MODELOS	REFERENCIA	Ø	MODELOS
A-1	110	AGRIA - CARRARA - IMER	C-5	160	CITROEN
A-2	160	AGRIA - AUSA	C-6	228	CITROEN - PEUGEOT-FIAT
A-3	160	AUSA	C-8*	215	CITROEN
A-4	160	AGRIA	C-9	235	CITROEN
A-5*	180	AUSTIN - INNOCENTI	C-10	230	FIAT
A-6	250	AUSA	C-11*	230	FIAT
A-7*	180	AUSTIN - INNOCENTI	C-12*	215	CITROEN
A-8*	190	VOLKSWAGEN - AUSTIN - ROVER	C-13*	200	CITROEN
A-10*	180	VOLKSWAGEN			
A-11*	180	ALFA ROMEO	D-2	180	MERCEDES D
A-12*	200	ALFA ROMEO	DD-2	180	PERKINS
A-13*	200	ALFA ROMEO	D-3	200	MERCEDES
A-14*	200	ALFA ROMEO	D-4	180	AUSA - B. J. R.
A-15*	200	ALFA ROMEO	D-6*	235	DAF
A-16*	215	ALFA ROMEO	D-7*	215	DAF
A-17*	215	ALFA ROMEO	D-8*	215	DAF
A-18*	215	ALFA ROMEO	D-9*	240	DAF
A-19*	228	ALFA ROMEO	D-10*	240	DAF
A-20*	240	ALFA ROMEO	D-11*	240	DAF
A-21*	267	ALFA ROMEO	D-12*	240	DAF
A-22*	200	ALFA ROMEO	D-13*	235	DAF
A-23*	190	ALFA ROMEO	D-14*	240	DAF
A-24*	210	ALFA ROMEO			
A-25*	210	ALFA ROMEO	E-4	200	MERCEDES - AVIA - EBRO
A-26*	200	ALFA ROMEO	EB-1	280	EBRO - MECO - EBRO KUBOTA
A-27*	210	ALFA ROMEO			FENWICH
A-28*	228	ALFA ROMEO	EB-2	330	AVIA - EBRO KUBOTA - ROMERO
A-29*	215	ALFA ROMEO	EB-3	330	EBRO
A-30*	228	ALFA ROMEO			
A-31*	228	ALFA ROMEO	F-5	170	FORD
A-32	180	AUSA	F-6	280	FENWICH
A-34	240	AUSA	F-7	300	
AH-1	180	AGRIA	F-8	200	FORD
AH-2	250	AGRIA	F-9	190	FORD
AH-3	250	AGRIA	F-10	242	FORD
AH-1 C	180	AGRIA	F-11*	220	FORD
AL-1	160	ONDO - P. G. S.	F-12*	220	FORD
AV-1	280	AVIA	F-13*	240	FORD
AV-2	300	AVIA - EBRO	F-15*	215	FORD
AV-4	300	AVIA	F-16*	220	FORD
			F-17*	170	FIAT
B-1	233	RENAULT	F-26*	170	AUTO-BIANCHI - FIAT - LANCIA
B-2	280	BARREIROS	FV-1	233	AVIA - EBRO
B-3	280	RENAULT - BARREIROS - LAURAK			
		SOLSUK	H-1	180	FIAT - LANCIA
B-4	280	HOLMAN IBERICA - MAQUINARIA	H-2*	225	HONDA
B-6	330	RENAULT	H-3*	200	HONDA
B-7*	215	BMW	H-4*	220	HONDA
B-8*	215	BMW	H-5*	215	HONDA
B-9*	228	BMW	H-6*	220	HONDA
B-10*	228	BMW	H-7*	220	HONDA
B-11*	228	BMW	H-8*	228	HONDA
B-12*	228	BMW	H-9*	220	HONDA
B-13*	215	BMW	H-10*	225	HONDA
B-15*	228	BMW	H-11*	280	HYUNDAI
B-16*	240	BMW	H-12*	215	HYUNDAI
B-17*	240	BMW			
B-18*	240	BMW	JD-4	250	JOHN DEERE
B-19*	240	BMW	JD-5	280	JOHN DEERE
			JD-6	280	JOHN DEERE
C-3	160	CITROEN	JD-7	250	JOHN DEERE
C-4	180	CITROEN	JV-1	232	EBRO

CONJUNTOS DE PRESIÓN

REFERENCIA	Ø	MODELOS	REFERENCIA	Ø	MODELOS
JV - 2	235	TALBOT - EBRO	R - 3	160	RENAULT
LR - 1	232	LAND ROVER - DUMPERSA	R - 4	160	RENAULT
LR - 2	240	EBRO - AVIA - LAND ROVER - NISSAN	R - 5	200	RENAULT
LR - 4	240	NISSAN	R - 7	170	ARO - DACIA - RENAULT
M - 5	215	MERCEDES	R - 8	160	RENAULT
M - 6	215	MERCEDES	R - 10	215	RENAULT
M - 7 *	215	MERCEDES	R - 20 *	215	ROVER
M - 8 *	200	MERCEDES	R - 21 *	190	ROVER
M - 9 *	228	MERCEDES	R - 22 *	200	ROVER
M - 10 *	228	MERCEDES	R - 23 *	228	ROVER
M - 11 *	215	MERCEDES	R - 25 *	240	ROVER
M - 12 *	215	MERCEDES	R - 26 *	240	ROVER
M - 13 *	228	MERCEDES	R - 27 *	240	ROVER
M - 14 *	240	MERCEDES	R - 28 *	240	ROVER
M - 16 *	215	NISSAN	R - 29 *	240	ROVER
M - 17 *	225	MITSUBISHI	R - 30 *	225	ROVER
M - 18 *	225	MITSUBISHI	R - 31 *	215	ROVER
M - 19 *	225	MITSUBISHI	R - 32 *	228	ROVER
M - 20 *	225	MITSUBISHI	R - 33 *	200	ROVER
M - 21 *	225	MITSUBISHI	R - 34	200	RENAULT
M - 22 *	240	MITSUBISHI	R - 35 *	200	ROVER
N - 5	228	MERCEDES	R - 36 *	215	ROVER
N - 6	180	NISSAN	R - 37 *	215	ROVER
N - 7	200	NISSAN	R - 38 *	215	ROVER
N - 8 *	242	NISSAN	R - 39 *	190	ROVER
N - 9 *	242	NISSAN	R - 40 *	190	ROVER
N - 10 *	240	NISSAN	R - 41 *	190	ROVER
N - 11 *	180	NISSAN	R - 42 *	215	ROVER
N - 12 *	200	NISSAN	R - 43 *	180	ROVER
N - 13 *	225	NISSAN	R - 44 *	180	ROVER
O - 5 *	190	OPEL	R - 45 *	190	ROVER
O - 6 *	180	OPEL	R - 46 *	190	ROVER
O - 7 *	200	OPEL	R - 47 *	180	ROVER
O - 9 *	200	OPEL	R - 48 *	267	ROVER
O - 10 *	230	OPEL	R - 49 *	240	ROVER
O - 11 *	200	OPEL	R - 50 *	267	ROVER
O - 12 *	215	OPEL	R - 51 *	267	ROVER
O - 13 *	200	OPEL	R - 52 *	215	ROVER
O - 14 *	190	OPEL	R - 54 *	200	RENAULT
O - 16	228	OPEL	R - 55 *	215	RENAULT
O - 17	170	OPEL	R - 56 *	215	RENAULT
P - 1	160	PASQUALI	RA - 5	180	SEAT - RAYGAR - VALPADANA
P - 3	180	PASQUALI	RA - 7	180	P. G. S. - RAYGAR
P - 4	190	PASQUALI	RA-305	180	
P - 5	180	EBRO KUBOTA	S - 1	160	TALBOT
P - 6	215	PEUGEOT	S - 3	160	TALBOT
P - 8	300	SAVA	S - 4	180	TALBOT
P - 9	235	PEUGEOT	S - 5	180	CITROEN - DACIA - PEUGEOT - RENAULT - TALBOT
P - 10 *	215	PEUGEOT	S - 6	180	TALBOT
P - 11	190	PASQUALI	S - 7	180	TALBOT
P - 15	215	PASQUALI	S - 8	160	TALBOT
P - 16	225	PASQUALI	S - 10	235	TALBOT
R - 1	160	CITROEN - RENAULT - COMEVASA COMOPLESIA - DITER - GUTHELFER - HUMSA - RAYGAR	S - 11	200	CITROEN - PEUGEOT - TALBOT
R - 2	160	OVAC	S - 12	155	SEAT - EBRO - DITER
			S - 13	215	SEAT - DUMPERSA - LAURAK - AUSA VALPADANA
			S - 14	200	SEAT - TALBOT
			S - 15	160	SEAT - VALPADANA
			S - 16	215	SEAT - PASQUALI
			S - 18	200	SEAT - MERCEDES

CONJUNTOS DE PRESIÓN

REFERENCIA	Ø	MODELOS	REFERENCIA	Ø	MODELOS
S-19	180	SEAT	V-4*	228	VOLKSWAGEN
SS-19	180	FIAT - SEAT	V-5*	228	VOLKSWAGEN
SS-19A	180	AGRIA	V-6*	180	VOLKSWAGEN
S-20	200	LADA - SEAT	V-7*	180	VOLKSWAGEN
SS-20	200	SEAT	V-8*	200	VOLKSWAGEN
S-21	160	AUTOBIANCHI - SEAT	V-9*	200	VOLKSWAGEN
S-22	180	TALBOT	V-10*	190	VOLKSWAGEN
S-23	200	FIAT - LANCIA - POLSKI - SEAT - AVIA-EBRO - SAVA	V-11*	190	VOLKSWAGEN
S-24	215	FIAT - SEAT - MERCEDES - AUSA	V-13*	210	VOLKSWAGEN
S-25	160	SEAT - EBRO	V-14*	200	VOLKSWAGEN
S-26	170	AUTOBIANCHI - SEAT - ZASTAVA	V-15*	210	VOLKSWAGEN
S-27	190	FIAT - FORD - SEAT - LANCIA	V-17*	228	VOLKSWAGEN
S-32	215	NISSAN	V-18*	200	VOLKSWAGEN
S-40	190	PEUGEOT - TALBOT	V-19*	190	VOLKSWAGEN
S-41	200	FIAT - SEAT	V-20*	200	VOLKSWAGEN
S-42	215	SEAT	V-21*	200	VOLKSWAGEN
S-50*	215	SAAB	V-22*	210	VOLKSWAGEN
S-51*	215	SAAB	V-23*	215	VOLKSWAGEN
S-52*	228	SAAB	V-24*	228	VOLKSWAGEN
S-53*	180	SKODA	V-25*	225	VOLKSWAGEN
S-54*	190	SKODA	V-26*	225	VOLKSWAGEN
S-55*	225	SUBARU	V-27*	225	VOLKSWAGEN
S-56*	225	SUBARU	V-28*	235	VOLKSWAGEN
S-57*	180	SUZUKI	V-30*	215	VOLKSWAGEN
S-58*	180	SUZUKI	V-31*	215	VOLKSWAGEN
S-59*	180	SUZUKI	V-32*	228	VOLKSWAGEN
S-60*	180	SUZUKI	V-33*	228	VOLKSWAGEN
S-61*	190	SUZUKI	V-34*	228	VOLKSWAGEN
S-62*	180	SUZUKI	V-35*	215	VOLVO
S-63*	200	SUZUKI	V-36*	215	VOLVO
S-64*	200	SUZUKI	V-38*	228	VOLVO
S-65*	215	SUZUKI	V-39*	215	VOLVO
S-66*	215	SUZUKI	V-40*	215	VOLVO
S-67*	215	TALBOT	V-41*	240	VOLVO
SN-1	280	TALBOT	V-42*	200	VOLVO
SR-1	280	MOTRANSA	V-43*	200	VOLVO
SR-2	250	EBRO KUBOTA - SAMARENAULT	V-44*	207	VOLVO
SV-1	229	SAMA RENAULT	V-45*	200	VOLVO
SV-2	255	SAVA	V-46*	228	VOLVO
SV-3	280	SAVA - B. J. R.	V-47*	228	VOLVO
SV-5	330	SAVA			
SV-6	280	SAVA - O. M.			
.....					
T-1*	215	TOYOTA			
T-2*	225	TOYOTA			
T-3*	225	TOYOTA			
T-4*	225	TOYOTA			
T-5*	240	TOYOTA			
T-6*	240	TOYOTA			
T-7*	225	TOYOTA			
T-8*	236	TOYOTA			
T-9*	225	TOYOTA			
T-11*	275	TOYOTA			
TY-45	250	POCLAIN			
TY-45 D	250	POCLAIN			
TY-70	280	POCLAIN			
TY-80	310	POCLAIN			
.....					
V-1*	228	VOLKSWAGEN			
V-2*	228	VOLKSWAGEN			
V-3*	215	VOLKSWAGEN			

KITS

DISCO - CONJUNTO - COJINETE

REFERENCIA	MODELOS	REFERENCIA	MODELOS
1000	SEAT-EBRO	1053	SEAT
1001	CITROEN	1054	SEAT
1002	SEAT	1055 *	ALFA ROMEO
1003	FIAT-LANCIA-POLSKI- SEAT-SAVA-ALFA-ROMEO	1056 *	ALFA ROMEO
1004	DACIA-RENAULT-ALFA ROMEO	1057	RENAULT
1005	RENAULT	1058	AUTOBIANCHI- FIAT-LANCIA
1006	ARO-DACIA-RENAULT	1059	CITROEN
1007	TALBOT	1060	CITROEN
1008	TALBOT	1061	CITROEN
1009	SEAT	1062	CITROEN
1010	FIAT-SEAT	1063	FIAT
1011	FORD	1064	FIAT
1012	TALBOT	1065	AUTOBIANCHI- FIAT-LANCIA
1013	SEAT-EBRO	1066	LANCIA
1014	FIAT-SEAT	1067	FORD
1015	SEAT	1068	LADA
1016	AUTOBIANCHI-SEAT-ZASTAVA	1069	LANCIA
1017	FORD	1070	LANCIA
1018	AUTOBIANCHI-SEAT	1071	FIAT-LANCIA
1019	SEAT	1072	PEUGEOT
1020	SEAT	1073	CITROEN-PEUGEOT
1021	CITROEN	1074	PEUGEOT-TALBOT
1022	RENAULT	1075	PEUGEOT
1023	SEAT	1076	PEUGEOT
1024	CITROEN-PEUGEOT-RENAULT	1077	RENAULT
1025	RENAULT	1078	RENAULT
1026	AVIA-EBRO	1079	
1027	AVIA-EBRO	1080	RENAULT
1028	AVIA-EBRO	1081	TALBOT
1029	SAVA	1082 *	VOLKSWAGEN
1030	RENAULT	1083 *	VOLKSWAGEN
1031	RENAULT	1084	CITROEN
1032	RENAULT	1085	CITROEN
1033	RENAULT	1086	CITROEN
1034	RENAULT	1087	CITROEN
1035	RENAULT	1088	OPEL
1036	RENAULT	1089	TALBOT
1037	SEAT	1090	TALBOT
1038	SEAT	1091	TALBOT
1039	SEAT	1092	TALBOT
1040	SEAT	1093	LAND ROVER
1041	PEUGEOT	1094	LAND ROVER
1042	PEUGEOT-TALBOT	1095	LAND ROVER
1043	TALBOT	1096	NISSAN
1044	TALBOT	1097	
1045	TALBOT	1098	FIAT
1046	SEAT	1099	PEUGEOT
1047	CITROEN-PEUGEOT-TALBOT	1100	EBRO
1048	TALBOT	1101 *	CITROEN
1049	TALBOT	1102 *	NISSAN
1050	PEUGEOT	1103 *	ALFA ROMEO
1051	CITROEN	1104 *	ALFA ROMEO
1052	RENAULT		

KITS

DISCO - CONJUNTO - COJINETE

REFERENCIA	MODELOS	REFERENCIA	MODELOS
1105 *	ALFA ROMEO	1158 *	DAF
1106 *	ALFA ROMEO	1159 *	DAF
1107 *	ALFA ROMEO	1160 *	DAF
1108 *	ALFA ROMEO	1161 *	DAF
1109 *	ALFA ROMEO	1162 *	FORD
1110 *	ALFA ROMEO	1163 *	FORD
1111 *	ALFA ROMEO	1164 *	FORD
1112 *	ALFA ROMEO	1165 *	HONDA
1113 *	AUDI	1166 *	HONDA
1114 *	AUDI	1167 *	HONDA
1115 *	AUDI	1168 *	HONDA
1116 *	AUDI	1169 *	HONDA
1117 *	AUDI	1170 *	HONDA
1118 *	AUDI	1171 *	HONDA
1119 *	AUDI	1172 *	HONDA
1120 *	AUDI	1173 *	HONDA
1121 *	AUDI	1174 *	HONDA
1122 *	AUDI	1175 *	HONDA
1123 *	AUDI	1176 *	HYUNDAI
1124 *	AUDI	1177 *	HYUNDAI
1125 *	AUDI	1178 *	MERCEDES
1126 *	AUDI	1179 *	MERCEDES
1127 *	AUDI	1180 *	MERCEDES
1128 *	AUDI	1181 *	MERCEDES
1129 *	AUDI	1182 *	MERCEDES
1130 *	AUDI	1183 *	MERCEDES
1131 *	AUDI	1184 *	MERCEDES
1132 *	AUDI	1185 *	MERCEDES
1133 *	BMW	1186 *	MERCEDES
1133 *	BMW	1187 *	MERCEDES
1134 *	BMW	1188 *	MERCEDES
1135 *	BMW	1189 *	MERCEDES
1136 *	BMW	1190 *	MERCEDES
1137 *	BMW	1191 *	MERCEDES
1138 *	BMW	1192 *	MERCEDES
1139 *	BMW	1193 *	MERCEDES
1140 *	BMW	1194 *	MERCEDES
1141 *	BMW	1195 *	
1142 *	BMW	1196 *	MITSUBISHI
1143 *	BMW	1197 *	MITSUBISHI
1144 *	BMW	1198 *	MITSUBISHI
1145 *	BMW	1199 *	MITSUBISHI
1146 *	BMW	1200 *	MITSUBISHI
1147 *	BMW	1201 *	MITSUBISHI
1148 *	BMW	1202 *	MITSUBISHI
1149 *		1203 *	MITSUBISHI
1150 *		1204 *	NISSAN
1151 *	DAF	1205 *	
1152 *	DAF	1206 *	NISSAN
1153 *	DAF	1207 *	NISSAN
1154 *	DAF	1208 *	NISSAN
1155 *	DAF	1209 *	NISSAN
1156 *	DAF	1210 *	RENAULT
1157 *	DAF	1211 *	ROVER

KITS

DISCO - CONJUNTO - COJINETE

REFERENCIA	MODELOS	REFERENCIA	MODELOS
1212 *	ROVER	1266 *	SUZUKI
1213 *	ROVER	1267 *	SUZUKI
1214 *	ROVER	1268 *	
1215 *	ROVER	1269 *	SUZUKI
1216 *	ROVER	1270 *	SUZUKI
1217 *	ROVER	1271 *	SUZUKI
1218 *	ROVER	1272 *	SUZUKI
1219 *	ROVER	1273 *	TOYOTA
1220 *	ROVER	1274 *	TOYOTA
1221 *	ROVER	1275 *	TOYOTA
1222 *	ROVER	1276 *	TOYOTA
1223 *	ROVER	1277 *	TOYOTA
1224 *	AUTHI-ROVER	1278 *	TOYOTA
1225 *	ROVER	1279 *	TOYOTA
1226 *	ROVER	1280 *	TOYOTA
1227 *	ROVER	1281 *	TOYOTA
1228 *	ROVER	1282 *	TOYOTA
1229 *	ROVER	1283 *	TOYOTA
1230 *	ROVER	1284 *	TOYOTA
1231 *	ROVER	1285 *	TOYOTA
1232 *	ROVER	1286 *	TOYOTA
1233 *	ROVER	1287 *	TOYOTA
1234 *	ROVER	1288 *	TOYOTA
1235 *	ROVER	1289 *	TOYOTA
1236 *	ROVER	1290 *	
1237 *	ROVER	1291 *	VOLKSWAGEN
1238 *	ROVER	1292 *	VOLKSWAGEN
1239 *	ROVER	1293 *	VOLKSWAGEN
1240 *	ROVER	1294 *	VOLKSWAGEN
1241 *	ROVER	1295 *	VOLKSWAGEN
1242 *	ROVER	1296 *	VOLKSWAGEN
1243 *	ROVER	1297 *	VOLKSWAGEN
1244 *	ROVER	1298 *	VOLKSWAGEN
1245 *	ROVER	1299 *	VOLKSWAGEN
1246 *	ROVER	1300 *	VOLKSWAGEN
1247 *	ROVER	1301 *	VOLKSWAGEN
1248 *	ROVER	1302 *	VOLKSWAGEN
1249 *	ROVER	1303 *	SEAT-VOLKSWAGEN
1250 *	ROVER	1304 *	VOLKSWAGEN
1251 *	ROVER	1305 *	VOLKSWAGEN
1252 *	SAAB	1306 *	VOLKSWAGEN
1253 *	SAAB	1307 *	VOLKSWAGEN
1254 *	SAAB	1308 *	VOLKSWAGEN
1255 *	SAAB	1309 *	
1256 *	SAAB	1310 *	VOLKSWAGEN
1257 *	SAAB	1311 *	VOLKSWAGEN
1258 *	SAAB	1312 *	VOLKSWAGEN
1259 *	SKODA	1313 *	VOLKSWAGEN
1260 *	SUBARU	1314 *	VOLKSWAGEN
1261 *	SUBARU	1315 *	VOLKSWAGEN
1262 *	SUZUKI	1316 *	VOLKSWAGEN
1263 *	SUZUKI	1317 *	VOLKSWAGEN
1264 *	SUZUKI	1318 *	VOLKSWAGEN
1265 *	SUZUKI	1319 *	VOLKSWAGEN

KITS

DISCO - CONJUNTO - COJINETE

REFERENCIA	MODELOS	REFERENCIA	MODELOS
1320 *	VOLKSWAGEN	1373 *	FORD
1321 *	VOLKSWAGEN	1374 *	FORD
1322 *	VOLKSWAGEN	1375 *	FORD
1323 *	VOLKSWAGEN	1376 *	FORD
1324 *	VOLKSWAGEN	1377 *	FORD
1325 *	VOLKSWAGEN	1378 *	FORD
1326 *	VOLKSWAGEN	1379 *	FORD
1327 *	VOLKSWAGEN	1380 *	INNOCENTI
1328 *	VOLKSWAGEN	1381 *	INNOCENTI
1329 *	VOLKSWAGEN	1382 *	OPEL
1330 *	VOLKSWAGEN	1383 *	OPEL
1331 *	VOLKSWAGEN	1384 *	OPEL
1332 *		1385 *	OPEL
1333 *	VOLKSWAGEN	1386 *	OPEL
1334 *	VOLKSWAGEN	1387 *	OPEL
1335 *	VOLKSWAGEN	1388 *	OPEL
1336 *	VOLKSWAGEN	1389 *	OPEL
1337 *	VOLKSWAGEN	1390 *	OPEL
1338 *	VOLKSWAGEN	1391 *	OPEL
1339 *	VOLKSWAGEN	1392 *	OPEL
1340 *	VOLKSWAGEN	1393 *	OPEL
1341 *	VOLVO	1394 *	OPEL
1342 *	VOLVO	1395 *	OPEL
1343 *	VOLVO	1396 *	OPEL
1344 *	VOLVO	1397 *	PEUGEOT
1345 *	VOLVO	1398 *	PEUGEOT
1346 *	VOLVO	1399 *	PEUGEOT
1347 *	VOLVO	1400 *	
1348 *	VOLVO	1401 *	RENAULT
1349 *	VOLVO	1402 *	RENAULT
1350 *	VOLVO	1403 *	RENAULT
1351 *	VOLVO	1404 *	
1352 *	VOLVO	1405 *	TALBOT
1353 *	VOLVO	1406 *	FIAT
1354 *		1407 *	AGRIA-CARRARO- IMER
1355 *	VOLVO	1408 *	AUDI-SKODA
1356 *	VOLVO	1409 *	AUDI-VOLKSWAGEN
1357 *	VOLVO	1410 *	AUDI-VOLKSWAGEN
1358 *	VOLVO	1411 *	AUDI-VOLKSWAGEN
1359 *		1412 *	AUDI
1360 *	VOLVO	1413 *	AUDI-VOLKSWAGEN
1361 *	VOLVO	1414 *	AUDI-VOLKSWAGEN
1362 *	VOLVO	1415 *	AUDI-VOLKSWAGEN
1363 *	VOLVO	1416 *	AUDI-VOLKSWAGEN
1364 *	VOLVO	1417 *	AUDI
1365 *	CITROEN-PEUGEOT	1418 *	AUDI
1366 *	CITROEN-PEUGEOT	1419 *	AUDI
1367 *	CITROEN	1420 *	CITROEN-PEUGEOT
1368 *	CITROEN	1421 *	CITROEN-PEUGEOT
1369 *	CITROEN	1422 *	DAIHATSU
1370 *	CITROEN	1423 *	DAIHATSU-TOYOTA
1371 *	CITROEN	1424 *	FORD
1372 *	FIAT		

KITS

DISCO - CONJUNTO - COJINETE

REFERENCIA	MODELOS	REFERENCIA	MODELOS
1425 *	FORD	1477 *	RENAULT
1426 *	FORD	1478 *	RENAULT
1427 *	FORD	1479 *	RENAULT
1428 *	FORD	1480 *	RENAULT
1429 *	FORD	1481 *	
1430 *	FORD-MAZDA	1482 *	RENAULT
1431 *	FORD-MAZDA	1483 *	SEAT
1432 *	FORD-MAZDA	1484 *	SEAT-VOLKSWAGEN
1433 *	INNOCENTI-FIAT	1485 *	SEAT-VOLKSWAGEN
	LANCIA-TOFAS	1486 *	SEAT
1434 *	INNOCENTI-FIAT	1487 *	SEAT-VOLKSWAGEN
1435 *	ISUZU	1488 *	SEAT-VOLKSWAGEN
1436 *	ISUZU	1489 *	SEAT-VOLKSWAGEN
1437 *	ISUZU-OPEL-VAUXHALL	1490 *	SEAT-VOLKSWAGEN
1438 *	ISUZU-OPEL-VAUXHALL	1600 *	MAZDA
1439 *	KIA-MAZDA	1601 *	
1440 *	LADA	1602 *	MERCEDES
1441 *	LANCIA	1603 *	MERCEDES
1442 *	LANCIA	1604 *	FORD
1443 *	LANCIA	1605 *	MERCEDES
1444 *	LANCIA-FIAT-AUTOBIANCHI	1606 *	TOYOTA
1445 *	LANCIA	1607 *	TOYOTA
1446 *	MERCEDES	1608 *	TOYOTA
1447 *	MERCEDES	1609 *	TOYOTA
1448 *	MITSUBISHI-HYUNDAI	1610 *	MITSUBISHI
1449 *	NISSAN	1611 *	TOYOTA
1450 *	NISSAN	1612 *	LANCIA
1451 *	NISSAN	1613 *	SAAB
1452 *	NISSAN	1614 *	OPEL-VAUXHALL
1453 *	NISSAN	1615 *	
1454 *	NISSAN	1616 *	FIAT
1455 *	NISSAN-RELIANT	1617 *	FORD
1456 *	NISSAN	1618 *	MERCEDES
1457 *	NISSAN	1619 *	MERCEDES
1458 *	NISSAN	1620 *	MERCEDES
1459 *	NISSAN	1621 *	FIAT-LANCIA
1460 *	NISSAN	1622 *	FIAT
1461 *	NISSAN	1623 *	ALFA ROMEO-FIAT
1462 *	NISSAN	1624 *	LAND ROVER-
1463 *	NISSAN		HONDA-
1464 *	NISSAN		ROVER GROUP
1465 *	NISSAN	1625 *	FIAT-LANCIA-
1466 *	OPEL-VAUXHALL		AUTOBIANCHI
1467 *	OPEL-VAUXHALL	1626 *	FIAT
1468 *	OPEL-VAUXHALL	1627 *	FORD
1469 *	OPEL-VAUXHALL	1628 *	MERCEDES
1470 *	OPEL-VAUXHALL	1629 *	OPEL-VAUXHALL
1471 *	OPEL-VAUXHALL	1630 *	OPEL-VAUXHALL
1472 *	RENAULT	1631 *	
1473 *	RENAULT	1632 *	OPEL-VAUXHALL-
1474 *	RENAULT		SAAB
1475 *	RENAULT	1633 *	OPEL-VAUXHALL
1476 *	RENAULT	1634 *	OPEL-VAUXHALL

KITS

DISCO - CONJUNTO - COJINETE

REFERENCIA	MODELOS	REFERENCIA	MODELOS
1635 *	OPEL-VAUXHALL	1684 *	ROVER GROUP
1636 *	OPEL-VAUXHALL	1685 *	
1637 *	CITROEN-PEUGEOT	1686 *	FIAT
1638 *	PEUGEOT	1687 *	HONDA
1639 *	CITROEN-PEUGEOT	1688 *	FORD
1640 *		1689 *	
1641 *	ALFA ROMEO-LANCIA	1690 *	NISSAN
1642 *	ALFA ROMEO	1691 *	ISUZU-VAUXHALL
1643 *	ALFA ROMEO-LANCIA- FIAT	1692 *	NISSAN
1644 *	FORD	1693 *	FIAT-LANCIA
1645 *	HONDA-LAND ROVER ROVER GROUP	1694 *	FIAT
1646 *	MAZDA	1695 *	
1647 *	AUDI	1696 *	ISUZU-VAUXHALL
1648 *	AUDI	1697 *	HONDA
1649 *	SEAT-VOLKSWAGEN	1698 *	HONDA
1650 *	CITROEN-FIAT-LANCIA- PEUGEOT	1699 *	HONDA
1651 *	CITROEN-FIAT-LANCIA- PEUGEOT	1700 *	MITSUBISHI
1652 *	CITROEN-FIAT-PEUGEOT	1701 *	MAZDA
1653 *		1702 *	NISSAN
1654 *	CITROEN-FIAT-PEUGEOT	1703 *	NISSAN
1655 *	CITROEN-PEUGEOT	1704 *	NISSAN
1656 *	CITROEN-PEUGEOT	1705 *	TOYOTA
1657 *	CITROEN-PEUGEOT	1706 *	FORD
1658 *	FORD	1707 *	FORD
1659 *	OPEL-VAUXHALL	1708 *	
1660 *	RENAULT	1709 *	FIAT
1661 *	RENAULT	1710 *	LANCIA
1662 *	HYUNDAI	1711 *	
1663 *		1712 *	OPEL-VAUXHALL
1664 *	VOLKSWAGEN	1713 *	OPEL-VAUXHALL
1665 *	VOLKSWAGEN	1714 *	OPEL-VAUXHALL
1666 *	VOLKSWAGEN	1715 *	LAND ROVER
1667 *	VOLKSWAGEN	1716 *	FORD-TAXI
1668 *	FIAT	1717 *	FORD
1669 *	CITROEN-PEUGEOT- ROVER GROUP	1718 *	FORD
1670 *		1719 *	FORD
1671 *	CITROEN-PEUGEOT	1720 *	
1672 *	FORD- SEAT-VOLKSWAGEN	1721 *	HONDA
1673 *	FORD-VOLKSWAGEN	1722 *	
1674 *	FORD	1723 *	FIAT-LANCIA
1675 *	FORD	1724 *	FORD
1676 *	FORD	1725 *	MAZDA
1677 *	FIAT	1726 *	NISSAN
1678 *	FIAT	1727 *	NISSAN
1679 *	FIAT	1728 *	FORD
1680 *	FIAT	1729 *	RENAULT
1681 *	LAND ROVER	1730 *	
1682 *	SEAT-VOLKSWAGEN	1731 *	OPEL-VAUXHALL
1683 *	NISSAN	1732 *	TOYOTA
		1733 *	FORD-LDV-TAXI
		1734 *	FORD
		1735 *	FIAT-IVECO
		1736 *	FIAT-IVECO
		1737 *	OPEL-RENAULT

KITS

DISCO - CONJUNTO - COJINETE

REFERENCIA	MODELOS	REFERENCIA	MODELOS
1738 *	HONDA	1789 *	FORD
1739 *	FORD	1790 *	NISSAN
1740 *	OPEL-VAUXHALL	1791 *	OPEL-VAUXHALL
1741 *	FIAT-LANCIA-TOFAS	1792 *	OPEL
1742 *	FORD	1793 *	OPEL-VAUXHALL
1743 *	FORD	1794 *	OPEL-VAUXHALL
1744 *	MAZDA	1795 *	RENAULT
1745 *	HONDA	1796 *	RENAULT
1746 *	MAZDA	1797 *	SEAT-VOLKSWAGEN
1747 *	NISSAN	1798 *	SUBARU
1748 *	ISUZU-VAUXHALL	1799 *	SUBARU
1749 *	CITROEN-PEUGEOT-TALBOT	1800 *	SUBARU
1750 *	LAND ROVER	1801 *	TALBOT
1751 *		1802 *	VOLVO
1752 *	FIAT	1803 *	VOLVO
1753 *	OPEL-VAUXHALL	1804 *	VOLVO
1754 *	RENAULT		
1755 *	PEUGEOT		
1756 *	CITROEN		
1757 *	PEUGEOT		
1758 *	RENAULT-VOLVO		
1759 *	RENAULT		
1760 *	AUTOBIANCHI		
1761 *	FIAT		
1762 *	FIAT		
1763 *	FORD-MAZDA		
1764 *	FIAT-LANCIA-YUGO		
1765 *	CITROEN PEUGEOT		
1766 *	CITROEN-PEUGEOT		
1767 *	CITROEN-PEUGEOT		
1768 *	CITROEN-PEUGEOT		
1769 *	CITROEN-FIAT- LANCIA-PEUGEOT		
1770 *	CITROEN-PEUGEOT		
1771 *	CITROEN-PEUGEOT-FOS		
1772 *	CITROEN-PEUGEOT		
1773 *	CITROEN-PEUGEOT- RENAULT-TALBOT		
1774 *	CITROEN-PEUGEOT - TALBOT		
1775 *	CITROEN-PEUGEOT -TALBOT		
1776 *	CITROEN-PEUGEOT - TALBOT		
1777 *	CITROEN-PEUGEOT- TALBOT-FIAT		
1778 *	CITROEN - PEUGEOT - FIAT - LANCIA		
1779 *	CITROEN-PEUGEOT		
1780 *	DAEWOO		
1781 *	DAIHATSU		
1782 *	DAIHATSU-TOYOTA		
1783 *	DAIHATSU-TOYOTA		
1784 *	DAIHATSU		
1785 *	AUTOBIANCHI - FIAT - LANCIA		
1786 *	FIAT-IVECO		
1787 *	FORD-OTASAN - RELIANT		
1788 *	FORD-RELIANT - TUR		







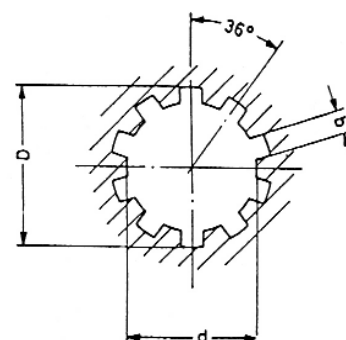

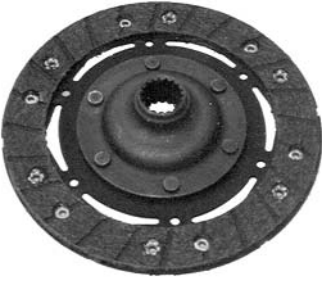

NORMAS DE ESTRIADO

ESTRIADOS SEGÚN NORMAS " DIN " 5464 / 5465				
d - D - b	Estrias	d mm	D mm	b mm
16 x 20 x 2,5	10	16 + 0,018	20 + 0,130	2,5 + 0,045 + 0,020
18 x 23 x 3	10	18 + 0,018	23 + 0,130	3 + 0,045 + 0,020
21 x 26 x 3	10	21 + 0,021	26 + 0,130	3 + 0,045 + 0,020
23 x 29 x 4	10	23 + 0,021	29 + 0,130	4 + 0,060 + 0,030
26 x 32 x 4	10	26 + 0,021	32 + 0,160	4 + 0,065 + 0,030
28 x 35 x 4	10	28 + 0,021	35 + 0,160	4 + 0,065 + 0,030
32 x 40 x 5	10	32 + 0,025	40 + 0,160	5 + 0,060 + 0,030
36 x 45 x 5	10	36 + 0,025	45 + 0,160	5 + 0,060 + 0,030
42 x 52 x 6	10	42 + 0,025	52 + 0,190	6 + 0,060 + 0,030







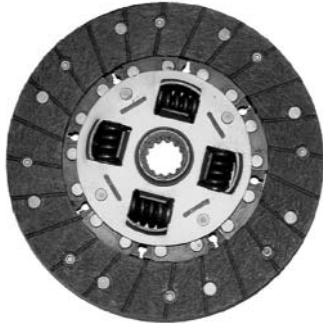

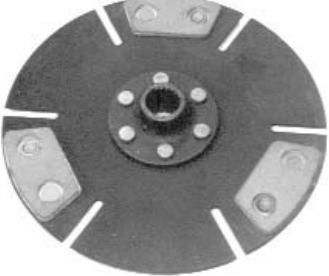

ESTRIADOS SEGÚN NORMAS " S.A.E. "				
D	Estrias	D mm	d mm	b mm
7/8 "	10	22,580 22,326	18,135 17,983	3,480 3,430
15/16 "	10	24,130 23,876	19,456 19,202	3,750 3,700
1 "	10	25,755 25,501	20,701 20,548	3,962 3,912
1 1/8 "	10	28,930 28,676	23,317 23,114	4,470 4,420
1 1/4 "	10	32,105 31,851	25,908 25,704	4,953 4,903
1 3/8 "	10	35,280 35,120	28,850 28,650	5,461 5,411
1 1/2 "	10	38,455 38,201	31,089 30,836	5,943 5,893
1 5/8 "	10	41,630 41,376	33,655 33,401	6,452 6,402
1 3/4 "	10	44,805 44,551	36,246 35,992	6,934 6,884
2 "	10	51,155 50,901	41,341 41,046	7,899 7,849



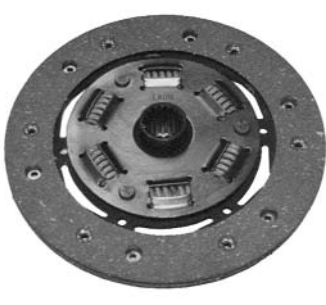











DISCOS (varios modelos)

1	2	3
<p style="text-align: center;">4 - 11</p>	<p style="text-align: center;">6 - 06 / 4</p>	<p style="text-align: center;">6 - 07 / 2</p>
		
4	5	6
<p style="text-align: center;">6 - 27 / 8</p>	<p style="text-align: center;">6 - 27 / 9</p>	<p style="text-align: center;">7 - 15 / B</p>
		
7	8	9
<p style="text-align: center;">7 - 17 / 9</p>	<p style="text-align: center;">7 - 36</p>	<p style="text-align: center;">7 - 94 / L</p>
		
10	11	12
<p style="text-align: center;">7 - 116 / 3</p>	<p style="text-align: center;">7 - 129</p>	<p style="text-align: center;">8 - 16</p>
		

DISCOS (varios modelos)

13	14	15
<p style="text-align: center;">8 - 49 / 1</p>	<p style="text-align: center;">8 - 49 / 1 PLCE</p>	<p style="text-align: center;">8 - 52</p>
		
16	17	18
<p style="text-align: center;">8 - 54</p>	<p style="text-align: center;">8 - 54 / 10</p>	<p style="text-align: center;">8 - 54 / 14</p>
		
19	20	21
<p style="text-align: center;">9 - 31</p>	<p style="text-align: center;">9 - 44</p>	<p style="text-align: center;">9 - 145 / 2</p>
		
22	23	24
<p style="text-align: center;">10 - 16</p>	<p style="text-align: center;">10 - 18</p>	<p style="text-align: center;">10 - 19</p>
		

DISCOS (varios modelos)

<p>25 10 - 27 / 2 PLCE</p>	<p>26 10 - 27 / 5</p>	<p>27 10 - 27 / 9</p>
		
<p>28 11 - 20</p>	<p>29 11 - 21 / D</p>	<p>30 11 - 47</p>
		
<p>31 11 - 49</p>	<p>32 12 - 10 / 4</p>	<p>33 12 - 11 / 3</p>
		
<p>34 12 - 52</p>	<p>35 12 - 78</p>	<p>36 13 - 64 / R</p>
		

DISCOS (varios modelos)

37

13 - 81 / 8 PLCE







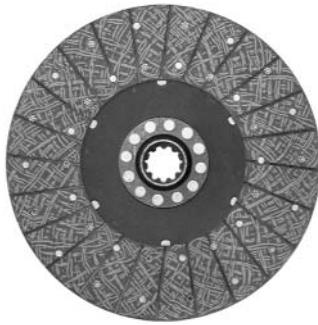







38













16 - 29 / D









CONJUNTOS (varios modelos)

39	A - 2	40	A - 6	41	A - 32			
			42	AH - 2	43	AV - 1	44	AV - 2
			45	C - 3	46	D - 2	47	D - 3
			48	D - 4	49	EB - 1	50	F - 5
								

CONJUNTOS (varios modelos)

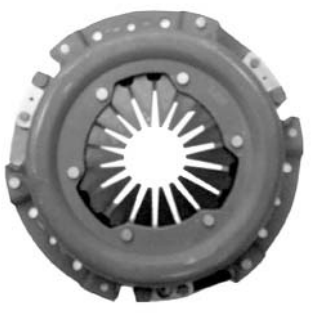
51	FV - 1	52	LR - 2			53	P - 3	
54	R - 1 / A - 2	55	R - 3			56	R - 7	
57	R - 8	58	RA - 5			59	S - 12	
60	S - 15	61	S - 16			62	S - 23	

CONJUNTOS (varios modelos)

63	S - 24	64	S - 26	65	S - 40
					
66	SS - 19	67	SV - 6	68	TY - 45
					
69	TY - 70	70	TY - 80		
					



Su distribuidor oficial

AGRÍCOLA BLASCO S.L.

Parque Agroalimentario L'Alcudia
C/Cerro de los Santos nº 23
ELCHE (Alicante) 03294
Telf y Fax 96 545 94 19

www.agricolablasco.com
www.agricolablascoonline.com
info@agricolablasco.com