

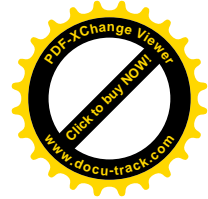

# Despiece motocultor LANDER **Serie 300**

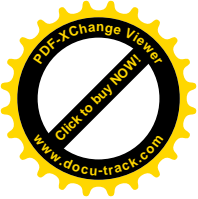



MOTOCULTOR- 300

CARIEK

Lamina 1

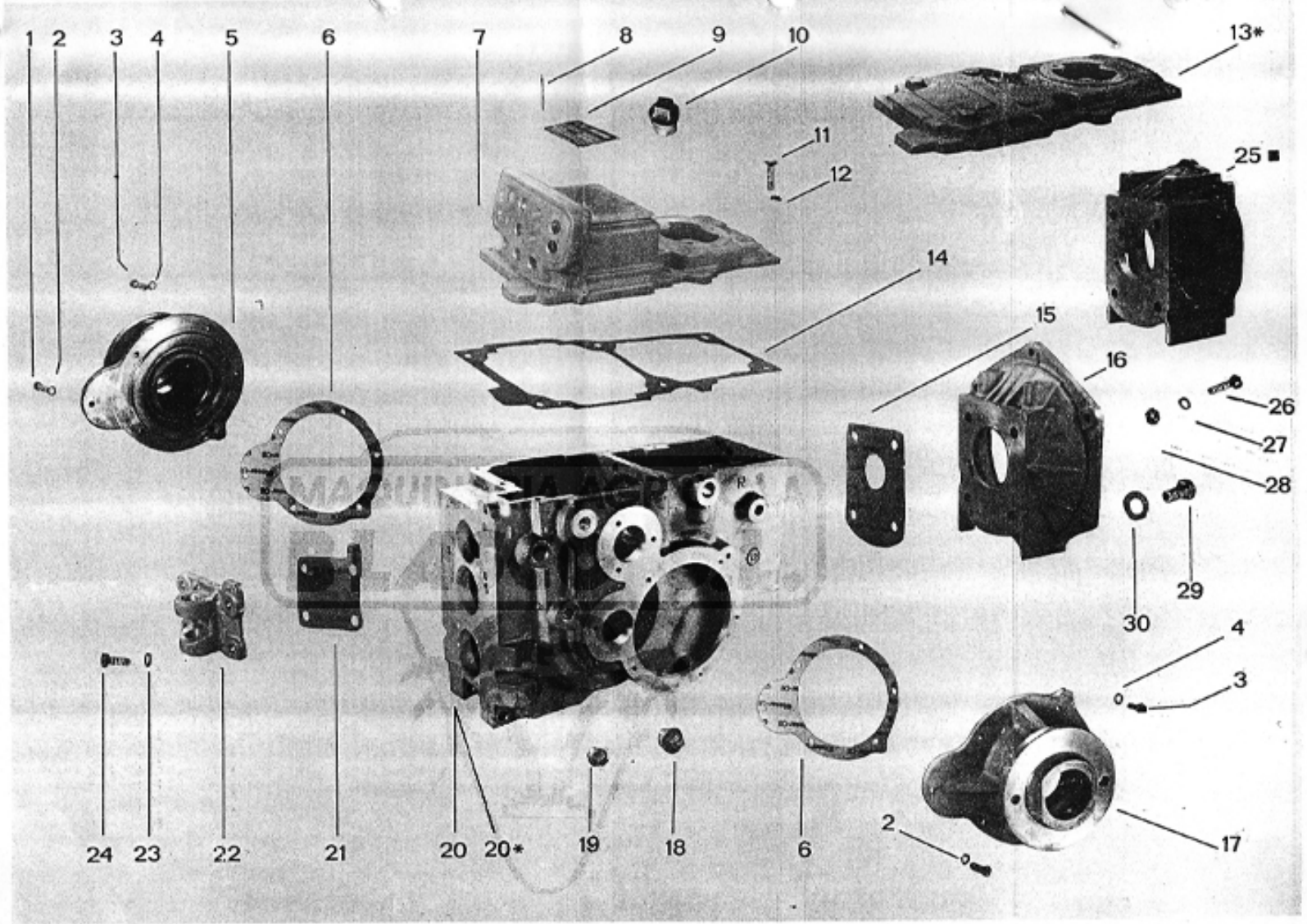

Nota: Las piezas marcadas con \* van montadas, en el tractor. Las piezas marcadas con ■ van montadas en el motocultor 10-12 c.v.

Agricola Blasco S.L. Telfno. 96 661 52 44 - Fax. 96 545 53 91. www.agricolablasco.com - info@agricolablasco.com.

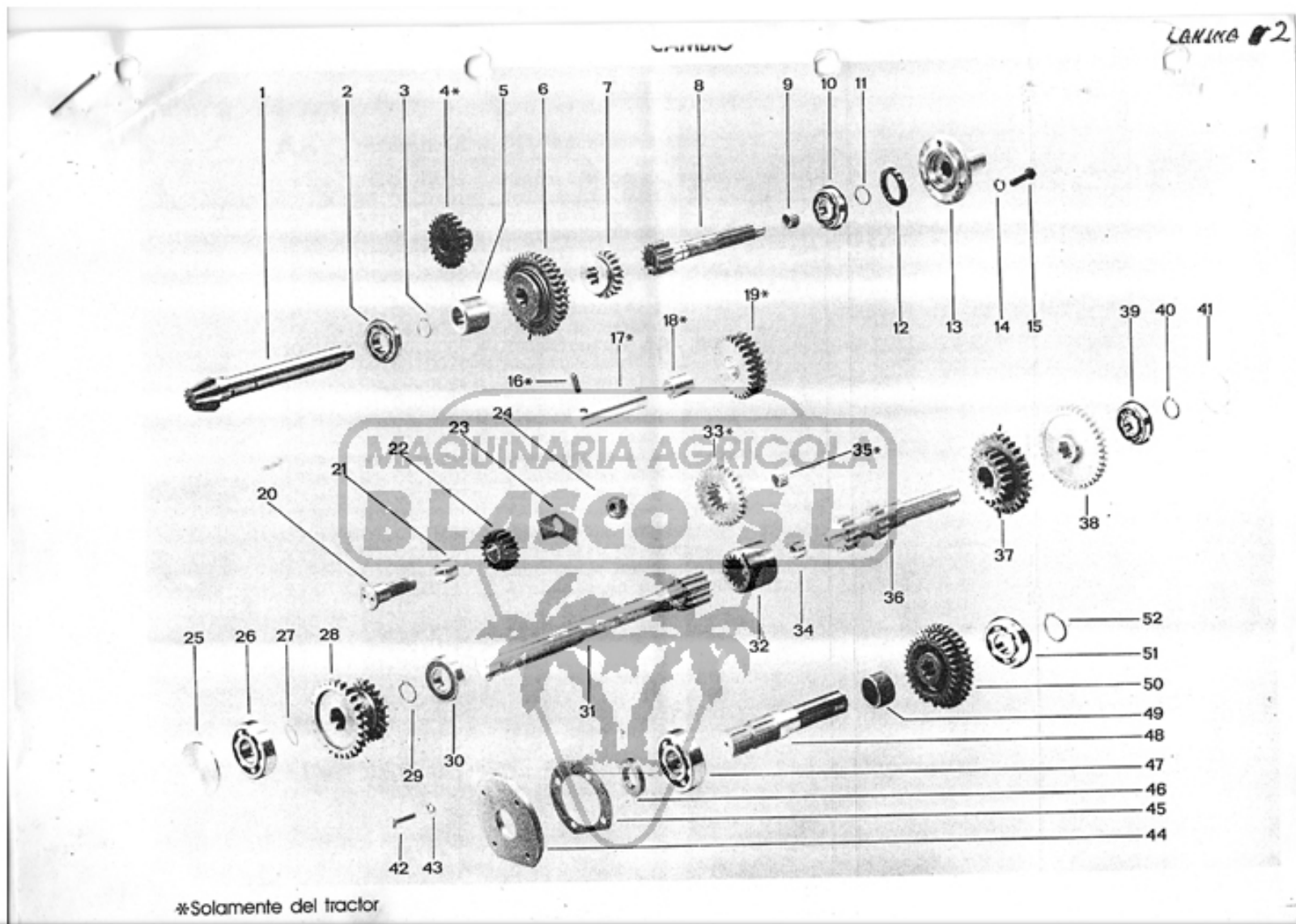
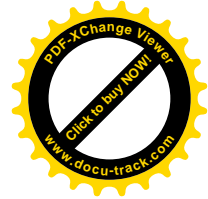
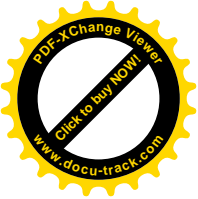



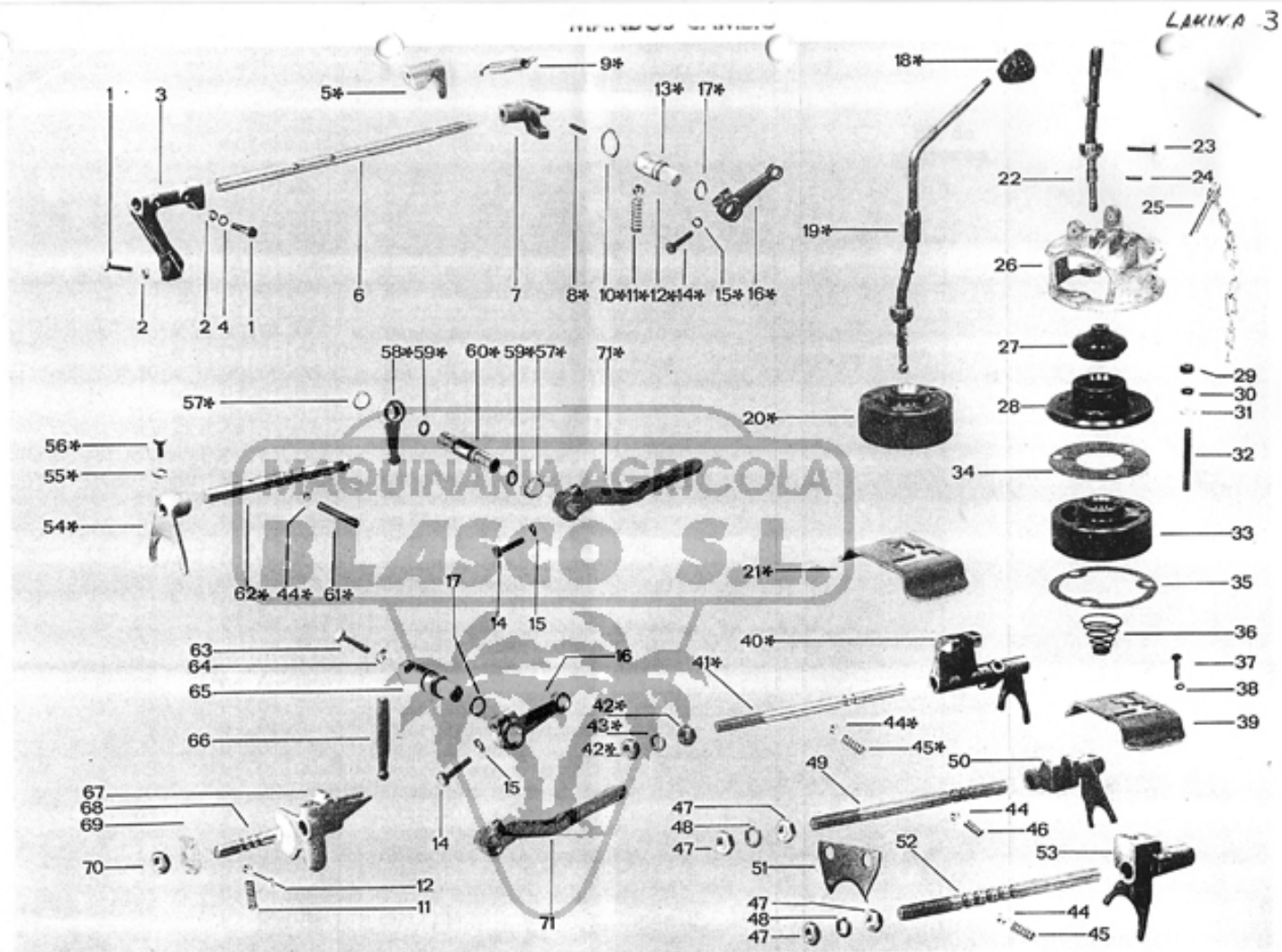

Nota: Las piezas marcadas con \* van montadas, en el tractor.

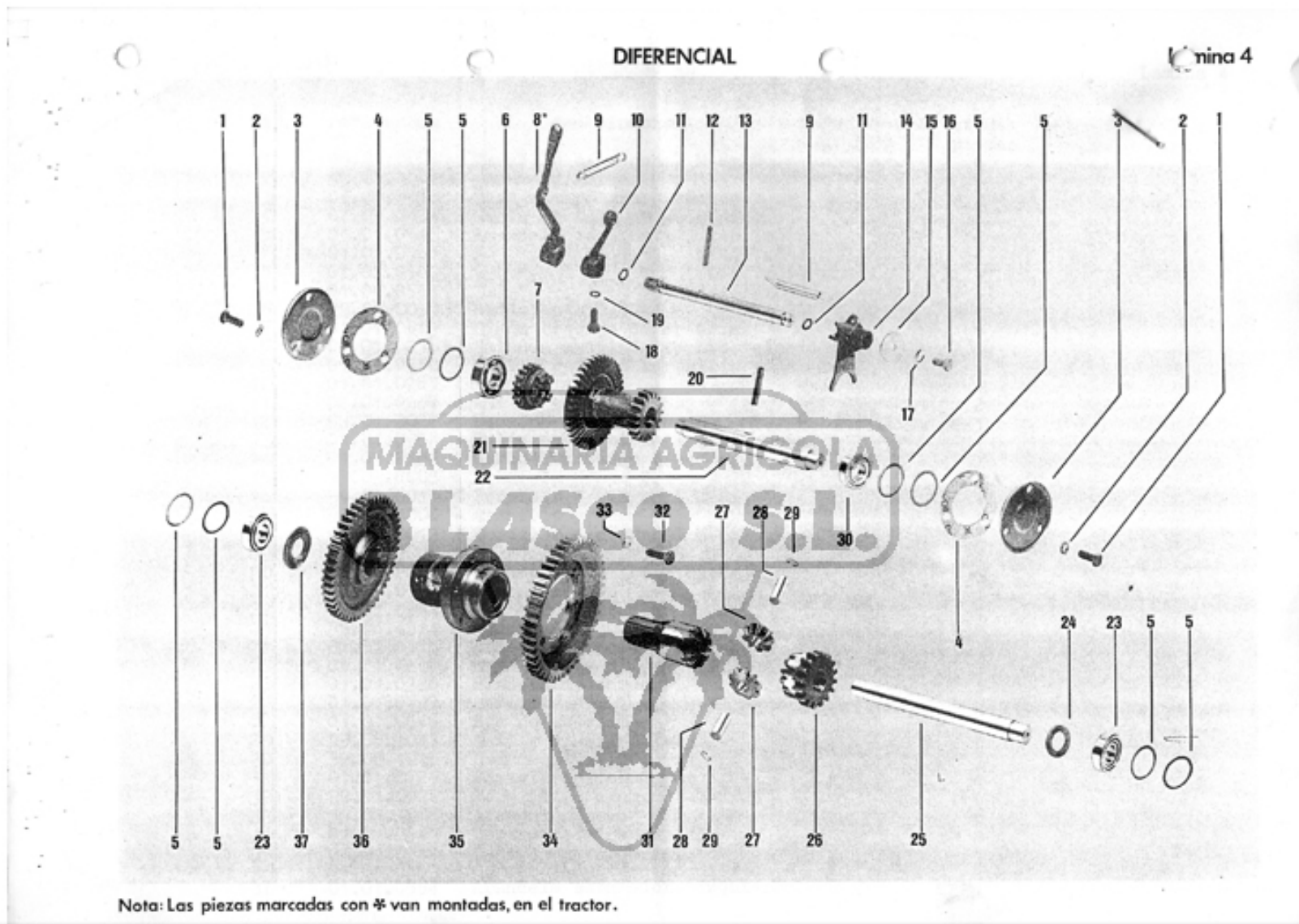
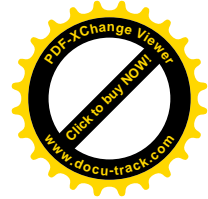
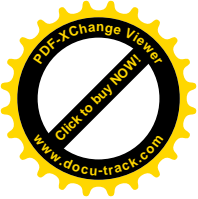

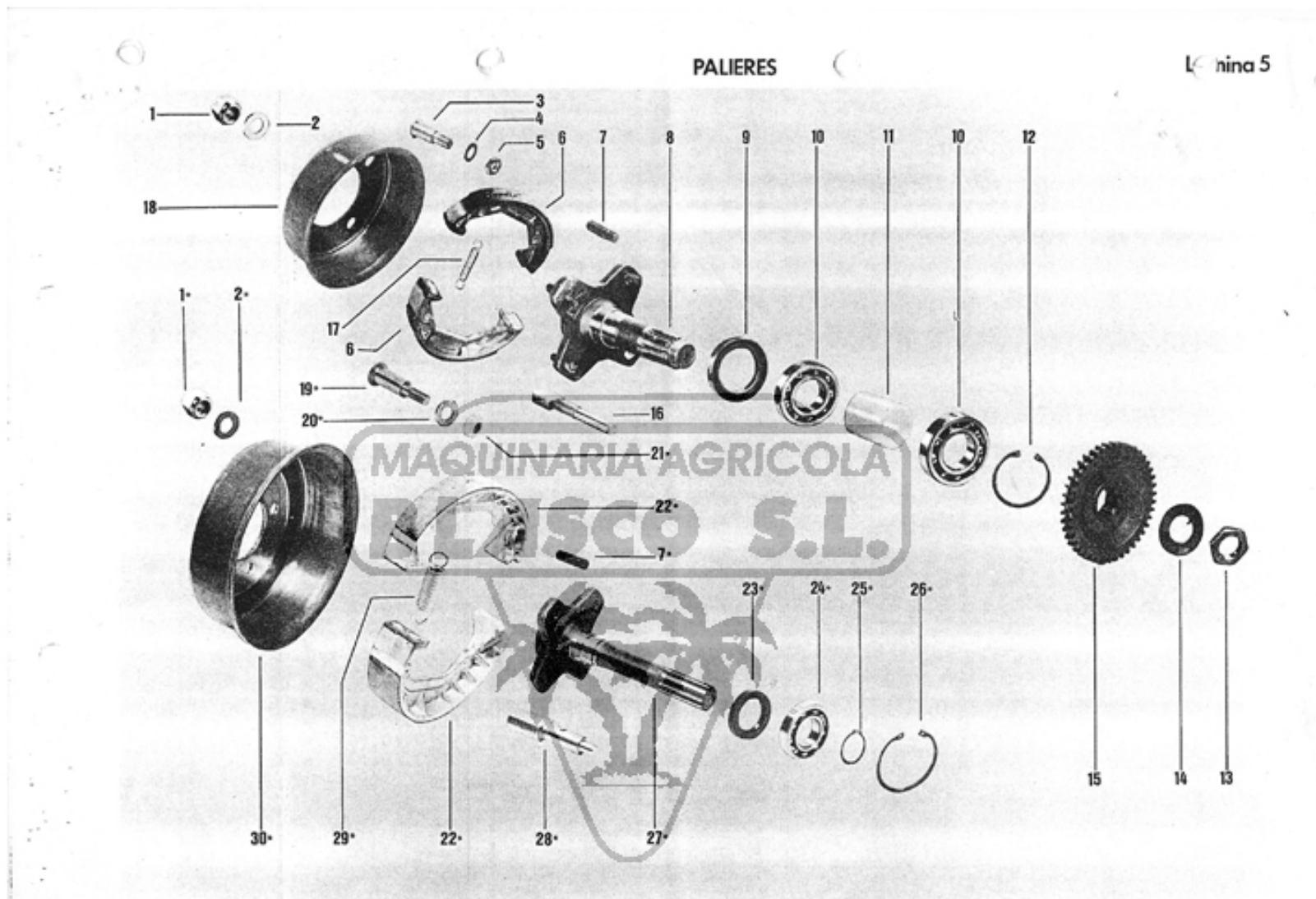
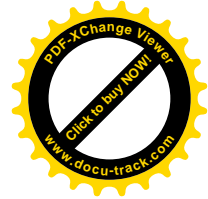
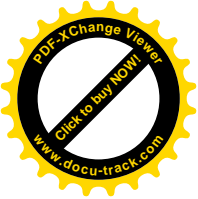

Nota: Las piezas marcadas con \* van montadas en el tractor.

Agricola Blasco S.L. Telfno. 96 661 52 44 - Fax. 96 545 53 91. [www.agricolablasco.com](http://www.agricolablasco.com) - [info@agricolablasco.com](mailto:info@agricolablasco.com).



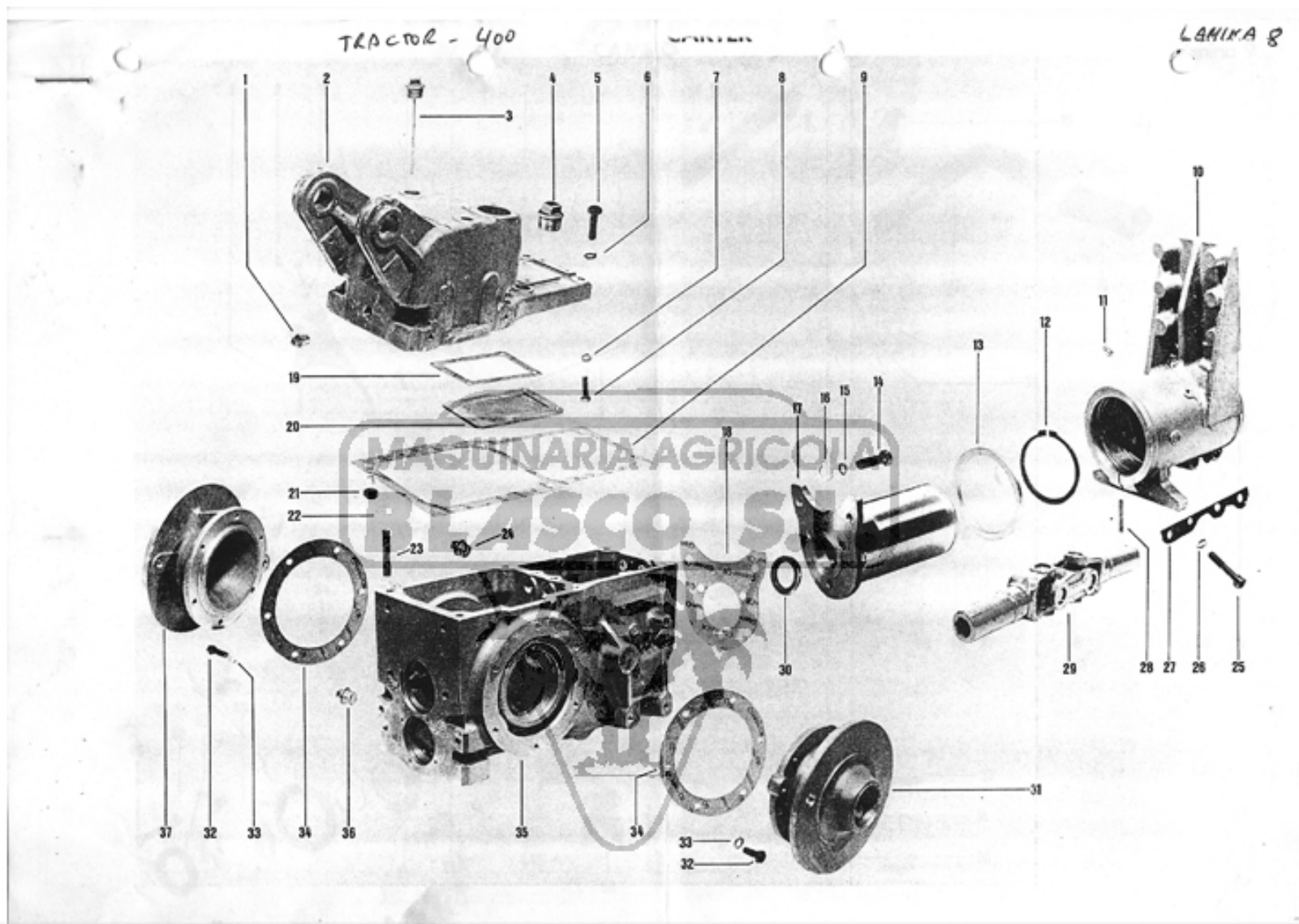
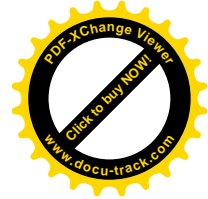
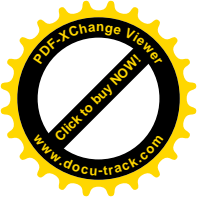

Agricola Blasco S.L. Telfno. 96 661 52 44 - Fax. 96 545 53 91. [www.agricolablasco.com](http://www.agricolablasco.com) - [info@agricolablasco.com](mailto:info@agricolablasco.com).

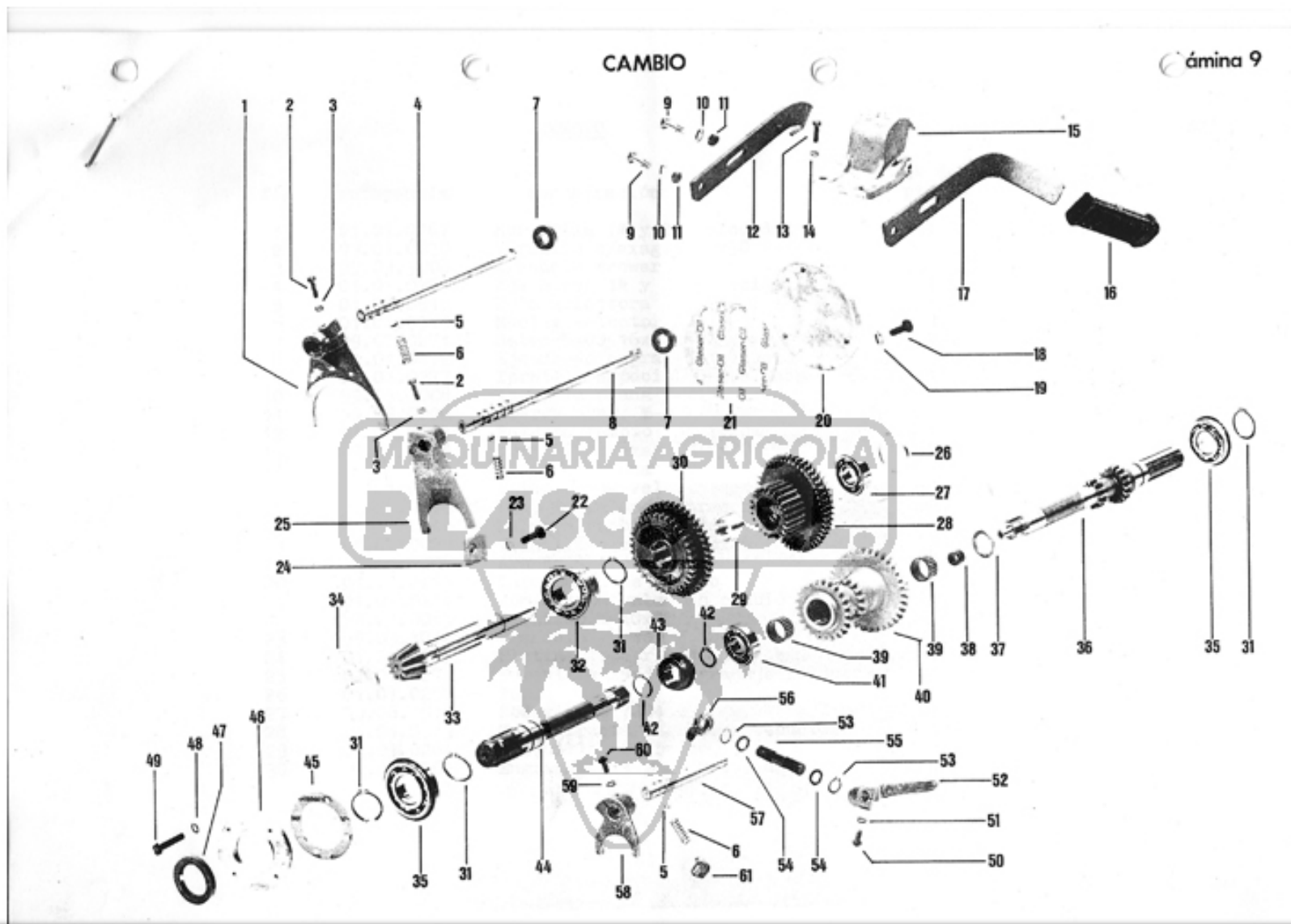
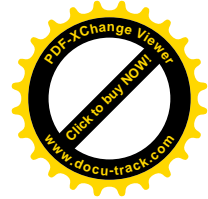
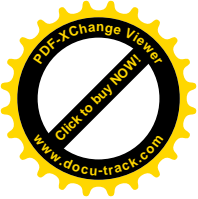



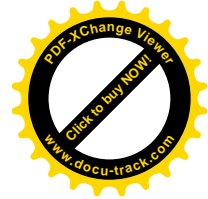
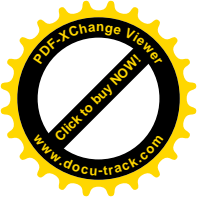

# DIFERENCIAL

Lámina 10

